



CREA TIVITY

Viefe[®]

 viefe.com

—
**HANDLES & KNOBS
CATALOGUE**

CREA TIVITY[∞]

CREATIVITY
TO INFINITY

eng

At Viefe® we have an infinite level of creativity. We apply it to all our designs processes and materials to achieve knobs handles and wall hooks that offer a wide range of possibilities for interior decoration.

Our products add a different touch to furniture and walls the change according to the finishes and the dimensions that the client may choose. Each model has multiple ways of being interpreted, all you need to do is imagine them and dare to try them.

We like to surprise, innovate and anticipate what's coming without forgetting the great classics. Fashions in interior design are our inspiration. Quality is our premise and functionality is our objective.

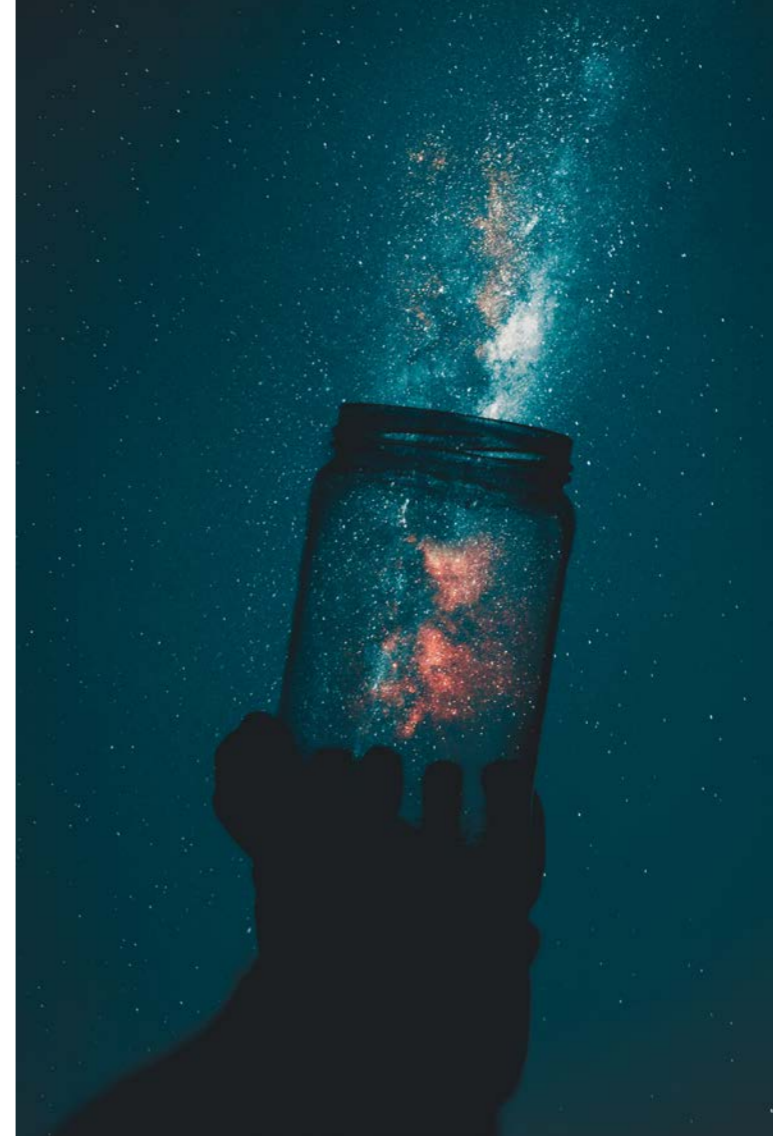

**Creatividad
al infinito**

esp

En Viefe® elevamos la creatividad al infinito. La aplicamos en todos nuestros diseños, procesos y materiales para conseguir pomos, tiradores y colgadores de pared que ofrecen un sinfín de posibilidades en decoración de interiores.

Nuestros productos aportan a los muebles y paredes un toque diferente que cambia en función de los acabados y las medidas que el cliente elige. Cada modelo tiene múltiples interpretaciones, solo hay que imaginarlas y atreverse a probar.

Nos gusta sorprender, innovar, avanzarnos a lo que vendrá sin olvidar los grandes clásicos. Las tendencias en interiorismo son nuestra inspiración. La calidad, nuestra premisa. La funcionalidad, nuestro objetivo.

**Creativitat
a l'infinit**

cat

A Viefe® elevem la creativitat a l'infinit. L'apliquem a tots els nostres dissenys, processos i materials per aconseguir pomos, tiradors i penjadors de paret que ofereixen un munt de possibilitats en decoració d'interiors.

Els nostres productes aporten als mobles i parets un toc diferent que canvia en funció dels acabats i les mides que el client escull. Cada model té múltiples interpretacions, només cal imaginar-les i atrevir-se a provar-les.

Ens agrada sorprendre, innovar, avançar-nos al que vindrà sense oblidar els grans clàssics. Les tendències en interiorisme són la nostra inspiració. La qualitat, la nostra premissa. La funcionalitat, el nostre objectiu.

BELIEVING IN GOOD DESIGN

eng

AESTHETICS & ERGONOMICS

We believe firmly in good design and in the importance of uniting aesthetics with ergonomics, in the practicality of use and the simplicity of installation. Our perfect finishes are the stamp which identifies us and means that our products fit perfectly in their final destination with maximum precision.



Estética y ergonomía

esp

Creemos firmemente en el buen diseño y en la importancia de la estética unida a la ergonomía. En la practicidad de uso y en la simplicidad de instalación. Nuestros acabados perfectos son el sello que nos identifica y permite que los productos encajen en su destino final con la máxima precisión.

Estètica i ergonomia

cat

Creiem fermament en el bon disseny i en la importància de l'estètica unida a l'ergonomia. En la practicitat d'ús i en la simplicitat d'instal·lació. Els nostres acabats perfectes són el segell que ens identifica i permet que els productes encaixin a la seva destinació final amb la màxima precisió.



OUR DESIGNERS

TALENT AND WORK

eng

We design all our products in Europe in collaboration with designers from around the world. Their talent provides us with different and daring perspectives. Their creativity helps us to discover new possibilities. Together we create knobs, handles and wall hooks that adapt to people's lifestyles and make their surroundings more pleasant.

ALEXIS VIVET / *Spain*
BALUTTO ASSOCIATI / *Italy*
FRANK PERSON / *Germany*
PATRICIA ROIG / *Spain*
KASCHKASCH / *Germany*
TERUEL-PARÉ / *Spain*
ULI BUDDE / *Germany*
BERNAT LLONCH / *Spain*
2J DESIGN / *USA*
HÉCTOR DIEGO / *Spain*
ORIOI BARRI / *Spain*
VIEFE® / *Spain*

Talento y trabajo

esp

Diseñamos todos nuestros productos en Europa en colaboración con diseñadores de todo el mundo. Su talento nos aporta miradas diferentes y transgresoras. Su creatividad nos hace descubrir nuevas posibilidades. Juntos creamos pomos, tiradores y colgadores de pared que se adaptan al estilo de vida de las personas y hacen más agradable su entorno.

Talent i treball

cat

Dissenyem tots els nostres productes a Europa en col·laboració amb dissenyadors de tot el món. El seu talent ens aporta mirades diferents i transgressores. La seva creativitat ens fa descobrir noves possibilitats. Junts creem poms, tiradors i penjadors de paret que s'adapten a l'estil de vida de les persones i fan més agradable el seu entorn.

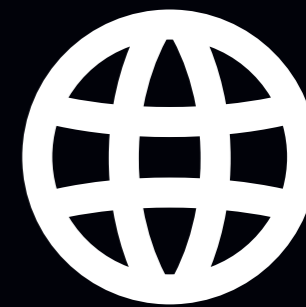

NEW SPACE



eng

WE HAVE GROWN

We have grown as a company and our premises too. Since 2021 we have been based at our new site of 3.000 m² which includes offices, a showroom and a logistics centre. Each detail has been thought out so that we can work just as we like to, attending to our customers in maximum comfort and ensuring our service is 100% efficient.

esp

Hemos crecido

Hemos crecido y nuestras instalaciones también. Desde 2021 estamos en un nuevo espacio de 3.000 m² que incluye oficinas, showroom y centro logístico. Cada detalle está pensado para que trabajemos a gusto, atendamos a nuestros clientes con la máxima comodidad y nuestro servicio sea 100% eficiente.

cat

Hem crescut

Hem crescut i les nostres instal·lacions també. Des del 2021 som a un nou espai de 3.000 m² que inclou oficines, showroom i centre logístic. Cada detall està pensat perquè treballem a gust, atenguem als nostres clients amb la màxima comoditat i el nostre servei sigui 100% eficient.



CONSCIENCE



eng

REDUCE & RECYCLE

Our planet's resources are limited. Luckily our creativity to make the most out of them responsibly isn't so limited. At Viefe® we are an ecologically conscious company that takes all the necessary measures to create products that are as sustainable as could possibly be and we optimize their packaging and transport so as to generate the minimum environmental impact.

esp

Reducir y reciclar

Los recursos del planeta son limitados. Por suerte, la creatividad para aprovecharlos con responsabilidad no lo es. En Viefe® somos una empresa eco-consciente, tomamos todas las medidas para crear productos lo más sostenibles posible y optimizamos su packaging y transporte para generar el mínimo impacto ambiental.

cat

Reducir i reciclar

Els recursos del planeta són limitats. Per sort, la creativitat per aprofitar-los amb responsabilitat no ho és. A Viefe® som una empresa eco-conscient, prenem totes les mesures per crear productes el més sostenibles possible i optimitzem el seu packaging i transport per generar el mínim impacte ambiental.



Viefe[®]

OUR PRODUCTS

—
NUESTROS
PRODUCTOS

—
ELS NOSTRES
PRODUCTES

20
22



0528

RILLE

ALUMINIUM

Designer: Patricia Roig

NEW!

Finishes
Acabados

Stainless steel look
Inox look

Brushed dark brass
Latón oscuro cepillado

Brushed black
Negro cepillado



| ←→ | ○ — ○ 1 | ○ — ○ 2 |
|---------|---------|---------|
| 55 mm | - | - |
| 190 mm | 160 mm | |
| 350 mm | 320 mm | |
| 510 mm | 480 mm | |
| 1022 mm | 992 mm | 496 mm |

⊕
Technical info on page 240
Info técnica en pág 240



0528

RILLE

ALUMINIUM

Designer: Patricia Roig

NEW!



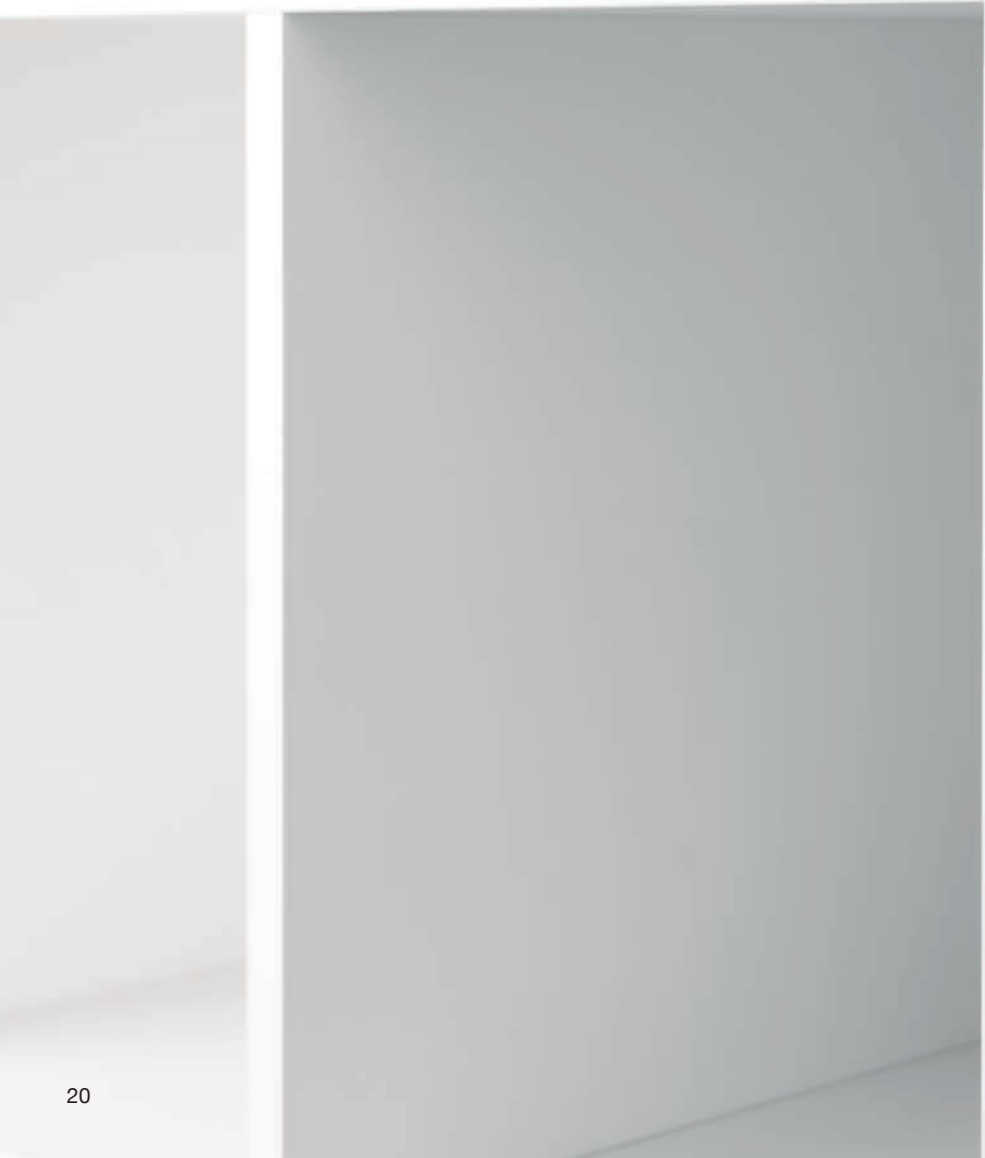

0528

RILLE

ALUMINIUM

Designer: Patricia Roig

NEW!

Finishes
Acabados

Stainless steel look
Inox look

Brushed dark brass
Latón oscuro cepillado

Brushed black
Negro cepillado

| ←→ | o — o 1 | o — o 2 |
|---------|---------|---------|
| 55 mm | - | - |
| 190 mm | 160 mm | |
| 350 mm | 320 mm | |
| 510 mm | 480 mm | |
| 1022 mm | 992 mm | 496 mm |



Technical info on page 240
Info técnica en pág 240



0530

DISC

WOOD

Designer: Balutto Associati

NEW!



Finishes
Acabados

Oak
Roble

Walnut
Nogal

Matt black lacquered
Negro mate lacado



38 mm
50 mm



Technical info on page 241
Info técnica en pág 241



0530

DISC

ZAMAK

Designer: Balutto Associati **NEW!**



Finishes
Acabados

Brushed nickel
Níquel cepillado

Brass
Latón

Matt white
Blanco mate

Matt black
Negro mate



38 mm
50 mm



Technical info on page 241
Info técnica en pág 241



0536

LUV

ZAMAK

Designer: Kaschkasch

NEW!

Finishes
Acabados

Brushed nickel
Níquel cepillado

Brass
Latón

Matt white
Bianco mate

Matt black
Negro mate

| ←→ | o — o |
|---------|--------|
| 51,2 mm | - |
| 202 mm | 192 mm |
| 330 mm | 320 mm |

Includes non-twisting tip
Incluye punta anti-giro



Technical info on page 240
Info técnica en pág 240



0536

LUV

ZAMAK

Designer: Kaschkasch

NEW!





0538

CONIC

WOOD

Designer: Kaschkasch

NEW!



Finishes
Acabados

Oak
Roble

Walnut
Nogal

Matt black lacquered
Negro mate lacado



29,4 mm

43 mm



Technical info on page 241
Info técnica en pág 241



0538

CONIC

ZAMAK

Designer: Kaschkasch

NEW!



**Finishes
Acabados**

Matt white
Blanco mate

Matt black
Negro mate

Moss grey
Gris musgo



29,4 mm

43 mm



Technical info on page 242
Info técnica en pág 242



0542

FOLD

ZAMAK

Designer: Teruel-Paré

NEW!

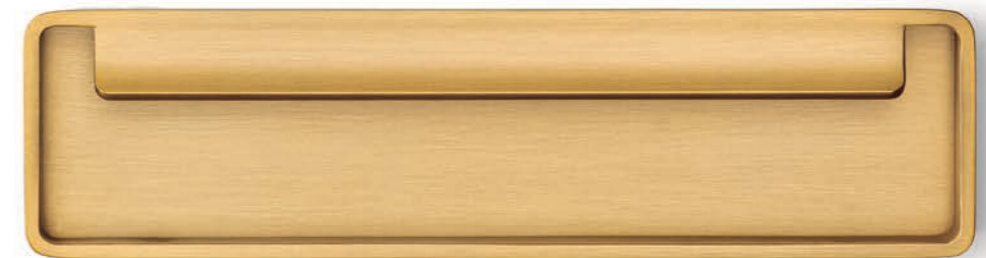

Finishes Acabados

Brushed nickel
Níquel cepillado

Brass
Latón

Matt white
Blanco mate

Matt black
Negro mate

←→ | ○ — ○
174 mm | 128 mm

⊕
Technical info on page 242
Info técnica en pág 242

0542

FOLD

ZAMAK

Designer: Teruel-Paré

NEW!



Finishes
Acabados

Brushed nickel
Níquel cepillado

Brass
Latón

Matt white
Blanco mate

Matt black
Negro mate

←→ | ○ — ○
174 mm | 128 mm



Technical info on page 242
Info técnica en pág 242



0543

SOFT

ZAMAK

Designer: Uli Budde

NEW!



**Finishes
Acabados**

| | ←→ | o — o |
|----------------------------------|--------|--------|
| Matt white <i>Blanco mate</i> | 40 mm | 32 mm |
| Matt black <i>Negro mate</i> | 200 mm | 192 mm |
| Moss grey <i>Gris musgo</i> | 328 mm | 320 mm |

⊕
Technical info on page 243
Info técnica en pág 243



0543

SOFT

ZAMAK

Designer: Uli Budde

NEW!





0552

RIM

ZAMAK

Designer: Bernat Llorch

NEW!

Finishes
Acabados

Brushed nickel
Níquel cepillado

Brass
Latón

Matt white
Blanco mate

Matt black
Negro mate

Moss grey
Gris musgo

←→ | o — o
120 mm 96 mm

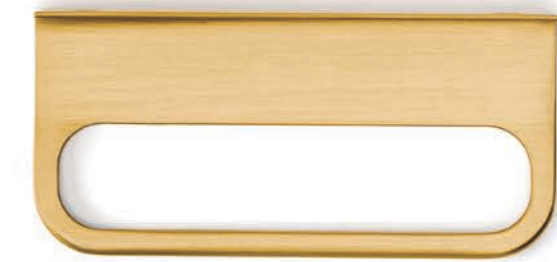
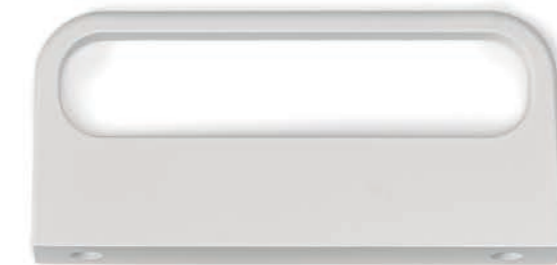

⊕
Technical info on page 243
Info técnica en pág 243



0553

OTO

ZAMAK

Designer: Bernat Lluch

NEW!



Finishes
Acabados

Black textured
Negro texturizado

| | |
|--------|--------|
| ←→ | o — o |
| 60 mm | - |
| 168 mm | 128 mm |

⊕
Technical info on page 244
Info técnica en pág 244



0556

DIPO

ZAMAK

Designer: Bernat Llorch

NEW!



Finishes
Acabados

Matt white
Blanco mate

Matt black
Negro mate

Moss grey
Gris musgo



74 mm



Technical info on page 244
Info técnica en pág 244



0583

ARPA

ALUMINIUM

Designer: Viefe®

NEW!

Finishes
Acabados

Stainless steel look
Inox look

Brushed dark brass
Latón oscuro cepillado

Brushed black
Negro cepillado

←→ | o — o 1 o — o 2

| | | | |
|---------|---------|--------|---|
| 70 mm | - | - | Includes non-twisting tip <i>Incluye punta anti-giro</i> |
| 214 mm | 192 mm | - | |
| 342 mm | 320 mm | - | |
| 1200 mm | 1178 mm | 589 mm | |



⊕
Technical info on page 245
Info técnica en pág 245

0583

ARPA

ALUMINIUM

Designer: Vief®

NEW!



0588

ARPA PLATE

ALUMINIUM

Designer: Viefie®

NEW!

Finishes Acabados

Stainless steel look
Inox look

Brushed dark brass
Latón oscuro cepillado

Brushed black
Negro cepillado

| ←→ | o — o 1 | o — o 2 |
|---------|---------|---------|
| 70 mm | - | - |
| 230 mm | 192 mm | - |
| 358 mm | 320 mm | - |
| 1216 mm | 1178 mm | 589 mm |

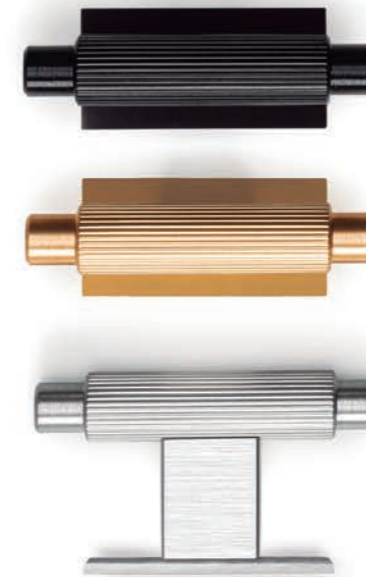

⊕
Technical info on page 245
Info técnica en pág 245



0372

ONA

ALUMINIUM

Designer: Teruel-Paré

Finishes
Acabados

Stainless steel look
Inox look

NEW! Brushed dark brass
Latón cepillado oscuro

Brushed black
Negro cepillado

Brushed grey
Gris cepillado

Matt white
Blanco mate

Metallic grey
Gris metal

Metallic brown
Marrón metal



| ←→ | ○ — ○ 1 | ○ — ○ 2 |
|---------|---------|---------|
| 50 mm | 32 mm | - |
| 200 mm | 128 mm | - |
| 350 mm | 256 mm | - |
| 600 mm | 544 mm | - |
| 1100 mm | 1056 mm | 416 mm |
| 1500 mm | 1440 mm | 480 mm |



Technical info on page 265
Info técnica en pág 265



0372

ONA

ALUMINIUM

Designer: Teruel-Paré

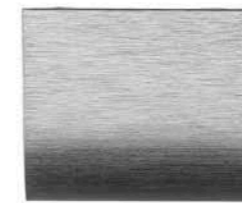
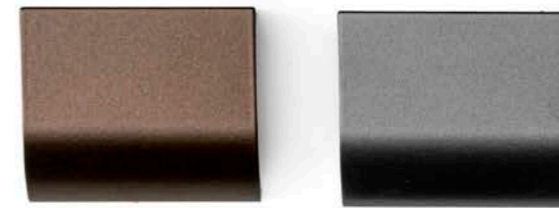
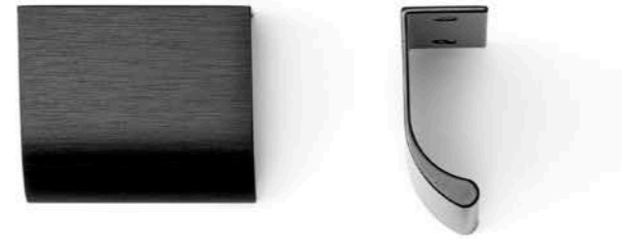

Finishes
Acabados

Stainless steel look
Inox look

NEW! Brushed dark brass
Latón cepillado oscuro

Brushed black
Negro cepillado

Brushed grey
Gris cepillado

Matt white
Blanco mate

Metallic grey
Gris metal

Metallic brown
Marrón metal

| ←→ | ○ — ○ 1 | ○ — ○ 2 |
|---------|---------|---------|
| 50 mm | 32 mm | - |
| 200 mm | 128 mm | - |
| 350 mm | 256 mm | - |
| 600 mm | 544 mm | - |
| 1100 mm | 1056 mm | 416 mm |
| 1500 mm | 1440 mm | 480 mm |



Technical info on page 265
Info técnica en pág 265

0254 / 0255

NOMA

ALUMINIUM

Designer: 2J Design



Finishes
Acabados

Anodized bright
Anodizado brillo

Stainless steel look
Inox look

NEW! Brushed black
Negro cepillado

Antique bronze
Bronce antiguo

NEW! Brushed brass cava
Latón cava cepillado

| | |
|--------|--------|
| ←→ | o — o |
| 200 mm | 128 mm |
| 350 mm | 256 mm |

⊕
Technical info on page 268
Info técnica en pág 268

0254 / 0255

NOMA

ALUMINIUM

Designer: 2J Design





Finishes Acabados

Polished chrome
Cromo brillo

Anodized matt
Anodizado mate

Stainless steel look
Inox look

NEW! Brushed dark brass
Latón oscuro cepillado

Matt White
Bianco mate

Matt black
Negro mate

Metallic grey
Gris metal

Metallic brown
Marrón metal

←→ | o — o

45 mm Consult technical info
90 mm Consultar info técnica

100 mm

120 mm

150 mm

190 mm

200 mm

250 mm

300 mm

400 mm

500 mm

600 mm

900 mm

1480 mm



Technical info on page 262
Info técnica en pág 262

0077

ANGLE

ALUMINIUM

Designer: Viefe®





0495

FLOID

ZAMAK

Designer: Frank Person



Finishes
Acabados

Brushed gold
Oro cepillado

Pewter
Peltre

Antique brass
Latón antiguo

Matt black
Negro mate

| ← → | o — o |
|----------|--------|
| Ø34,8 mm | - |
| 143,6 mm | 128 mm |
| 207,6 mm | 192 mm |

⊕
Technical info on page 246
Info técnica en pág 246



0496

BAU

ZAMAK

Designer: Patricia Roig



Finishes
Acabados

Brushed nickel
Níquel cepillado

Brushed gold
Oro cepillado

Matt black
Negro mate

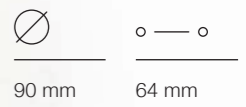

⊕
Technical info on page 246
Info técnica en pág 246

0127

JEY

ALUMINIUM

Designer: Vief©



Finishes
Acabados

Stainless steel look
Inox look

Brushed brass cava
Latón cava cepillado

Matt white
Blanco mate

Matt black
Negro mate

←→|

147 mm
197 mm
247 mm
297 mm
347 mm
397 mm
447 mm
497 mm
597 mm
697 mm
797 mm
897 mm
997 mm
1197 mm
3000 mm*

* Available only in M1
and M2 finishes

*Disponible solo en los
acabados M1 y M2*

⊕
Technical info on page 247
Info técnica en pág 247



0127 **JEY**

0163 **JEY2** (above)

ALUMINIUM

Designer: Viefef®

Finishes
Acabados

Stainless steel look
Inox look

Brushed brass cava
Latón cava cepillado

Matt white
Blanco mate

Matt black
Negro mate

←→|

147 mm
197 mm
247 mm
297 mm
347 mm
397 mm
447 mm
497 mm
597 mm
697 mm
797 mm
897 mm
997 mm
1197 mm
3000 mm*

* Available only in M1
and M2 finishes

*Disponible solo en los
acabados M1 y M2*



Technical info on page 247
Info técnica en pág 247



0487

PURA

ZAMAK

Designer: Balutto Associati



Finishes
Acabados

Polished chrome
Cromo brillo

Polished black nickel
Níquel negro brillo

Polished copper
Cobre brillo

Polished brass
Latón brillo

←→ | o — o

168 mm 160 mm



Technical info on page 246
Info técnica en pág 246



0168

COMO

ZAMAK

Designer: Viefef®



Finishes
Acabados

Polished chrome
Cromo brillo

Polished black nickel
Niquel negro brillo

Polished copper
Cobre brillo

Polished brass
Latón brillo



26 mm

41 mm



Technical info on page 248
Info técnica en pág 248



0168

COMO

ZAMAK

Designer: Viefef®

Finishes
Acabados

Matt chrome
Cromo mate

Brushed nickel
Níquel cepillado

Brushed copper
Cobre cepillado

Brushed gold
Oro cepillado

Matt black
Negro mate

Matt white
Blanco mate



26 mm

41 mm



Technical info on page 248
Info técnica en pág 248



0497

DIABOLO

ALUMINIUM

Designer: Frank Person



Finishes Acabados

Stainless steel look
Inox look

Brushed dark brass
Latón oscuro cepillado

Brushed black
Negro cepillado

Brushed grey
Gris cepillado



13,5 mm



Technical info on page 248
Info técnica en pág 248



0499

ROUND

ALUMINIUM

Designer: Balutto Associati



Finishes
Acabados

Stainless steel look
Inox look

Brushed dark brass
Latón oscuro cepillado

Brushed black
Negro cepillado



25 mm



Technical info on page 248
Info técnica en pág 248



0490

SWITCH

ZAMAK

Designer: Viefel®



Finishes
Acabados

Brushed nickel
Níquel cepillado

Matt white
Blanco mate

Matt black
Negro mate

| | |
|--------|--------|
| ←→ | ○ — ○ |
| 50 mm | 32 mm |
| 200 mm | 160 mm |

⊕
Technical info on page 249
Info técnica en pág 249



0518

WAY

ALUMINIUM

Designer: Viefte®



Finishes
Acabados

| | ←→ | ○ — ○ 1 | ○ — ○ 1/2 | ○ — ○ 2 |
|---|---------|---------|-----------|---------|
| Anodized matt <i>Anodizado mate</i> | 50 mm | 32 mm | - | - |
| | 100 mm | 64 mm | - | - |
| Stainless steel look <i>Inox look</i> | 200 mm | 128 mm | - | - |
| | 400 mm | 320 mm | - | - |
| Brushed dark brass <i>Latón oscuro cepillado</i> | 800 mm | 736 mm | 368 mm | - |
| Matt White <i>Blanco mate</i> | 1100 mm | 1056 mm | - | 352 mm |
| Matt black <i>Negro mate</i> | | | | |

⊕
Technical info on page 249
Info técnica en pág 249

0518

WAY

ALUMINIUM

Designer: Viefte®

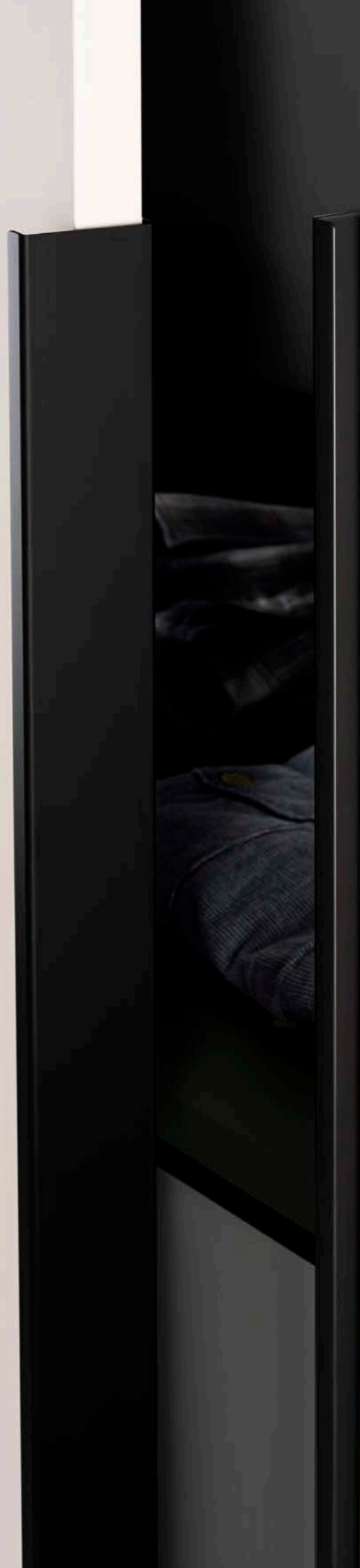

Finishes
Acabados

Anodized matt
Anodizado mate

Stainless steel look
Inox look

Brushed dark brass
Latón oscuro cepillado

Matt White
Blanco mate

Matt black
Negro mate

| ←→ | o — o 1 | o — o 1/2 | o — o 2 |
|---------|---------|-----------|---------|
| 50 mm | 32 mm | - | - |
| 100 mm | 64 mm | - | - |
| 200 mm | 128 mm | - | - |
| 400 mm | 320 mm | - | - |
| 800 mm | 736 mm | 368 mm | - |
| 1100 mm | 1056 mm | - | 352 mm |

⊕
Technical info on page 249
Info técnica en pág 249



0511

RAIL

ALUMINIUM

Designer: Teruel & Paré



Finishes
Acabados

Stainless steel look
Inox look

Brushed black
Negro cepillado

Brushed brass cava
Latón cava cepillado

| ←→ | o — o 1 | o — o 2 |
|-----------|---------|---------|
| 180 mm | 160 mm | - |
| 280 mm | 192 mm | - |
| 600 mm | 576 mm | 192 mm |
| * 1150 mm | 1120 mm | 192 mm |

* Off-center / *Descentrado*

⊕
Technical info on page 250
Info técnica en pág 250



0511

RAIL

ALUMINIUM

Designer: Teruel & Paré



Finishes

Acabados

Stainless steel look
Inox look

Brushed black
Negro cepillado

Brushed brass cava
Latón cava cepillado

←→ | o — o 1 o — o 2

| | | |
|-----------|---------|--------|
| 180 mm | 160 mm | - |
| 280 mm | 192 mm | - |
| 600 mm | 576 mm | 192 mm |
| * 1150 mm | 1120 mm | 192 mm |

* Off-center / *Descentrado*



Technical info on page 250
Info técnica en pág 250



0056

U

ZAMAK

Designer: Viefe®

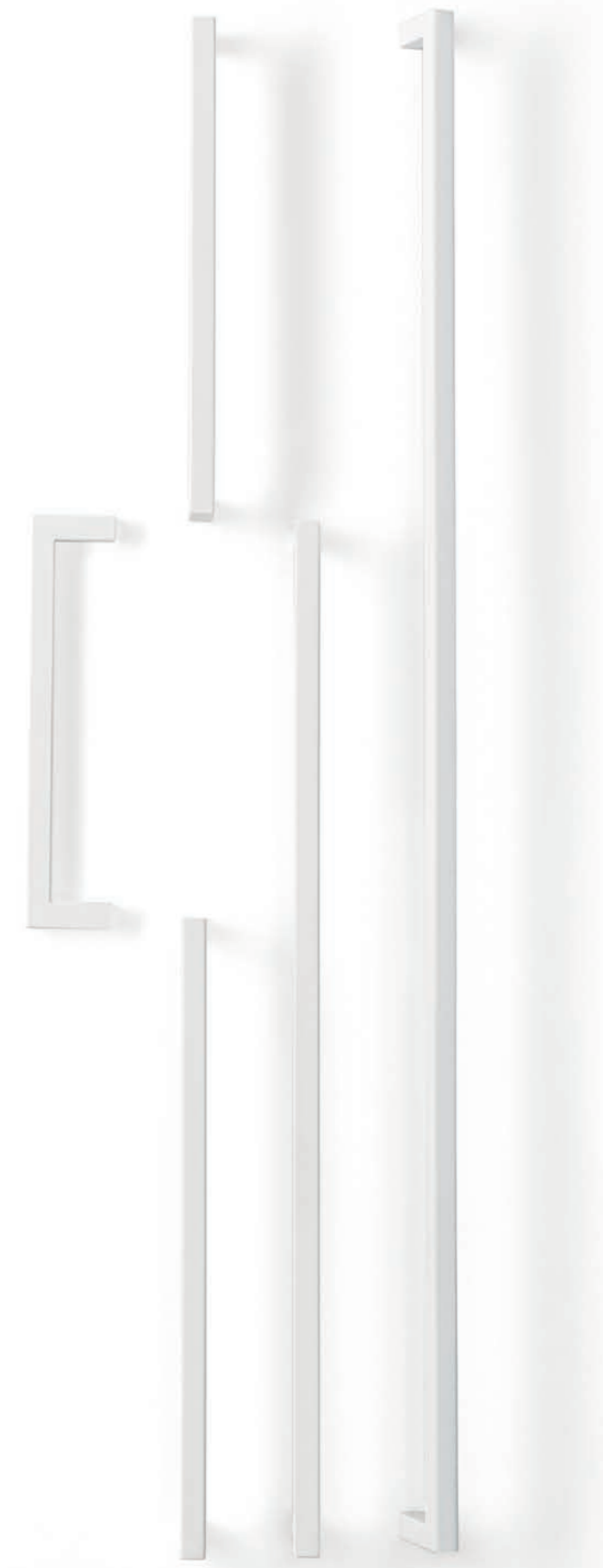

Finishes
Acabados

Matt white
Blanco mate

| ←→ | o — o |
|----------|--------|
| 136,5 mm | 128 mm |
| 168,5 mm | 160 mm |
| 200,5 mm | 192 mm |
| 328,5 mm | 320 mm |
| 500,5 mm | 492 mm |

⊕
Technical info on page 250
Info técnica en pág 250



0056

U

ZAMAK

Designer: Viefef®

Finishes
Acabados

| | ←→ | o — o |
|---|----------|--------|
| Polished chrome <i>Cromo brillo</i> | 136,5 mm | 128 mm |
| Matt chrome <i>Cromo mate</i> | 168,5 mm | 160 mm |
| Matt nickel <i>Niquel cepillado</i> | 200,5 mm | 192 mm |
| Brushed nickel <i>Niquel cepillado</i> | 328,5 mm | 320 mm |
| Matt black <i>Negro mate</i> | | |
| Brushed copper <i>Cobre cepillado</i> | | |
| Brushed brass <i>Latón cepillado</i> | | |
| Matt white <i>Blanco mate</i> | | |
| Brushed grey <i>Gris cepillado</i> | | |



Technical info on page 250
Info técnica en pág 250



0241

ROMA

ZAMAK

Designer: 2J Design

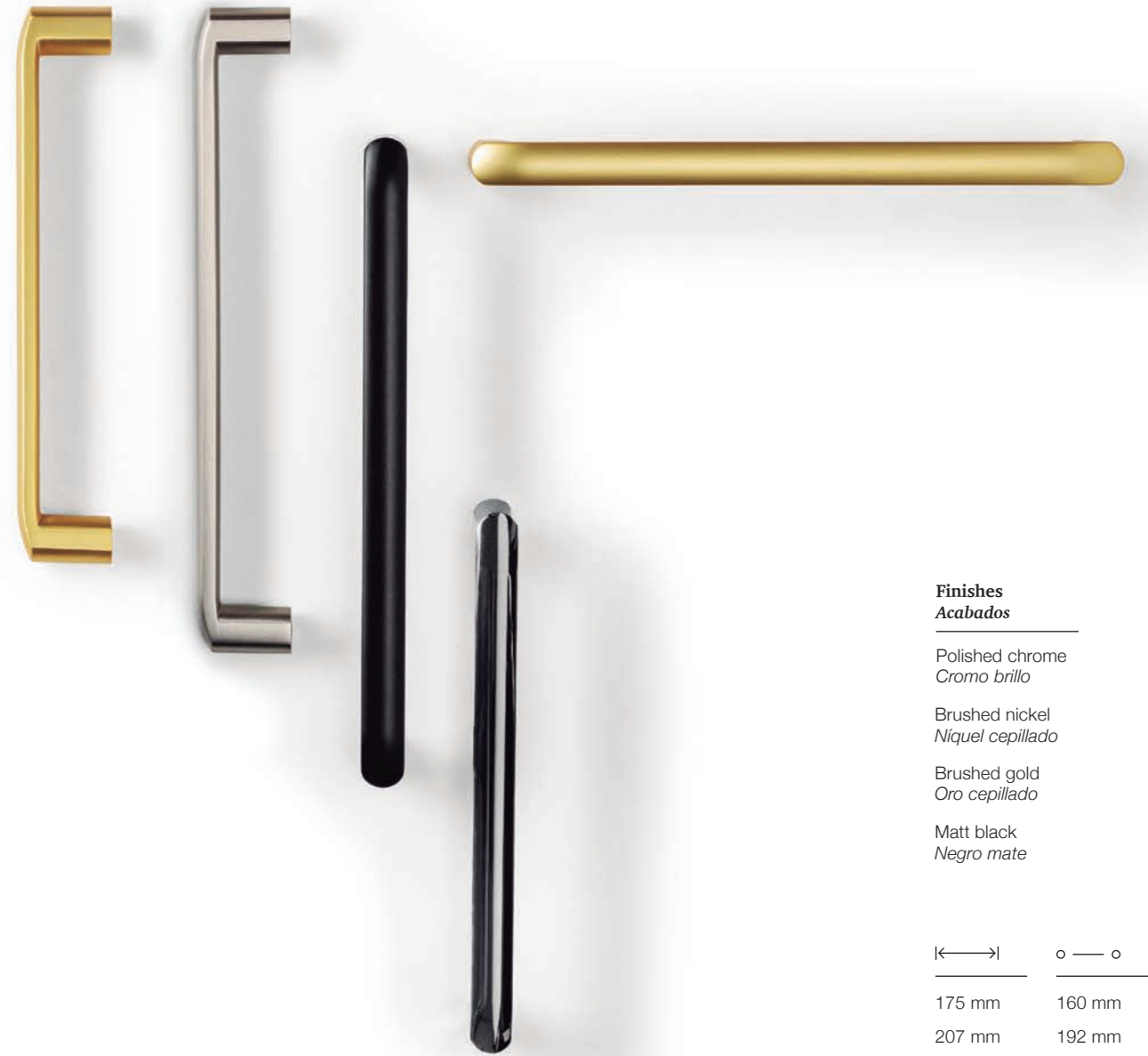

Finishes
Acabados

Polished chrome
Cromo brillo

Brushed nickel
Níquel cepillado

Brushed gold
Oro cepillado

Matt black
Negro mate

| ←→ | o — o |
|--------|--------|
| 175 mm | 160 mm |
| 207 mm | 192 mm |
| 335 mm | 320 mm |

⊕
Technical info on page 251
Info técnica en pág 251



0241

ROMA

ZAMAK

Designer: 2J Design



Finishes
Acabados

Polished chrome
Cromo brillo

Brushed nickel
Níquel cepillado

Brushed gold
Oro cepillado

Matt black
Negro mate

←→ | | →
○ — ○

175 mm 160 mm

207 mm 192 mm

335 mm 320 mm



Technical info on page 251
Info técnica en pág 251



0503

WALLACE

ZAMAK

Designer: Alexis Vivet

Finishes Acabados

Polished chrome
Cromo brillo

Polished black nickel
Níquel negro brillo

Polished copper
Cobre brillo

Polished brass
Latón brillo

←→ | o — o
210 mm 128 mm

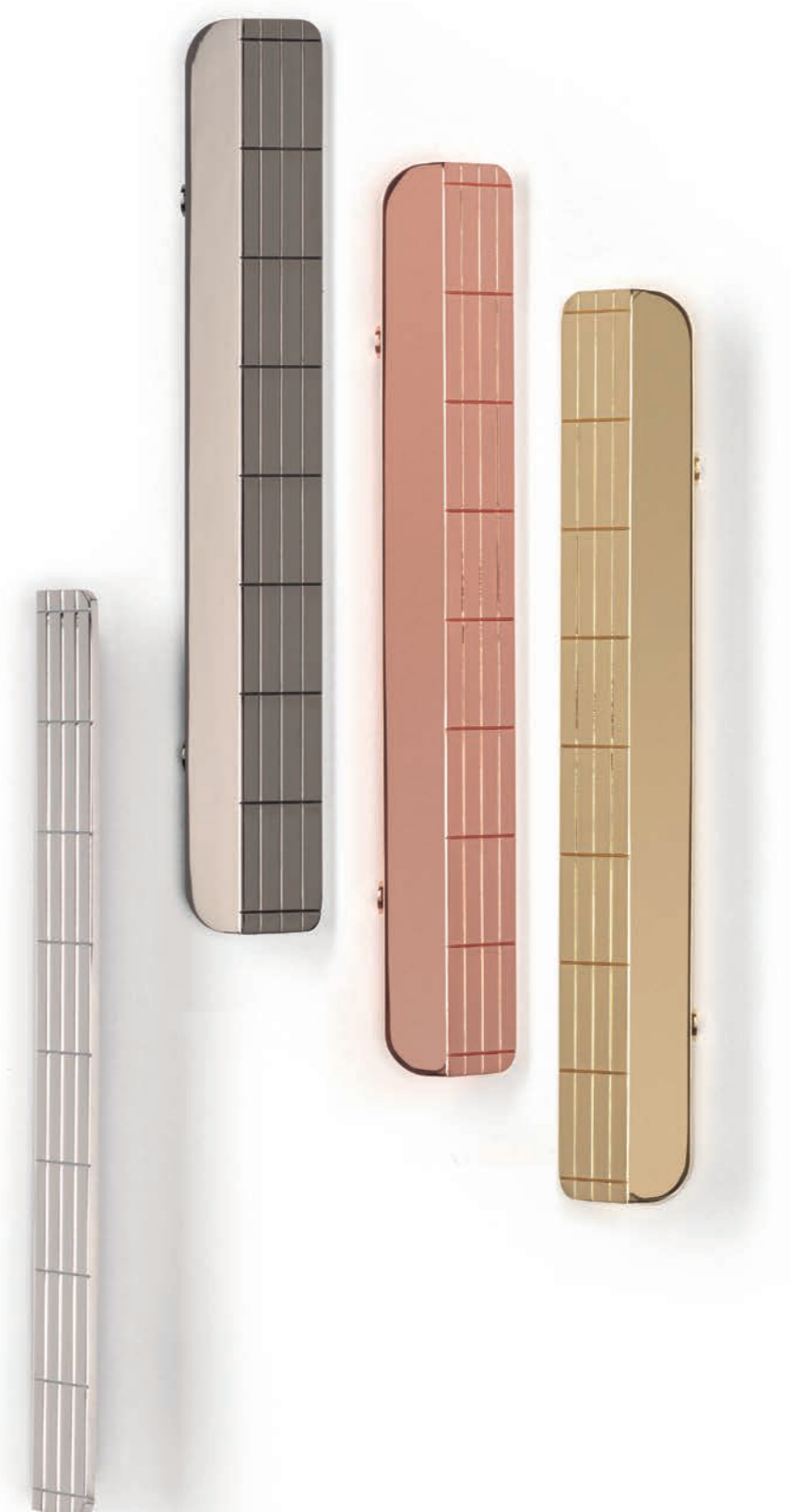

⊕
Technical info on page 251
Info técnica en pág 251



0489

BOL

ZAMAK / WOOD

Designer: Balutto Associati

Finishes Acabados

Matt black + Sapelly
Negro mate + Sapelly

Matt black + Beech
Negro mate + Haya

Matt black + Matt white lacquered
Negro mate + Lacado blanco mate



45 mm



Technical info on page 251
Info técnica en pág 251



0507

OBLONG

LEATHER / ZAMAK

Designer: Frank Person

Finishes Acabados

Polished chrome + Beige / Brown / Black
Cromo brillo + Beige / Marrón / Negro

Brushed gold + Beige / Brown / Black
Oro cepillado + Beige / Marrón / Negro

Brushed grey + Beige / Brown / Black
Gris cepillado + Beige / Marrón / Negro

Matt white + Beige
Blanco mate + Beige

Matt black + Beige / Brown / Black
Negro mate + Beige / Marrón / Negro

| | |
|--------|--------|
| ↳ — ↳ | ○ — ○ |
| 70 mm | - |
| 197 mm | 160 mm |



Technical info on page 252
Info técnica en pág 252

0507

OBLONG

LEATHER / ZAMAK

Designer: Frank Person



Finishes Acabados

Polished chrome + Beige / Brown / Black
Cromo brillo + Beige / Marrón / Negro

Brushed gold + Beige / Brown / Black
Oro cepillado + Beige / Marrón / Negro

Brushed grey + Beige / Brown / Black
Gris cepillado + Beige / Marrón / Negro

Matt white + Beige
Blanco mate + Beige

Matt black + Beige / Brown / Black
Negro mate + Beige / Marrón / Negro

| | |
|--------|--------|
| ←→ | ○ — ○ |
| 70 mm | - |
| 197 mm | 160 mm |

⊕
Technical info on page 252
Info técnica en pág 252

0494

LAND

ZAMAK

Designer: Héctor Diego



Finishes
Acabados

Brushed gold
Oro cepillado

Pewter
Peltre

Antique brass
Latón antiguo

Matt black
Negro mate

|←→| ○ — ○

40 (Ø) mm -

98 mm 64 mm

⊕
Technical info on page 253
Info técnica en pág 253



0494

LAND

ZAMAK

Designer: Héctor Diego



Finishes
Acabados

Brushed gold
Oro cepillado

Pewter
Peltre

Antique brass
Latón antiguo

Matt black
Negro mate

| | |
|-----------|-------|
| | |
| 40 (Ø) mm | - |
| 98 mm | 64 mm |

Technical info on page 253
Info técnica en pág 253



0506

FIRM

ZAMAK

Designer: Frank Person



Finishes
Acabados

Textured black
Negro texturizado

| ←→ | o — o |
|----------|--------|
| 93,8 mm | 64 mm |
| 125,8 mm | 96 mm |
| 189,8 mm | 160 mm |
| 349,8 mm | 320 mm |

⊕
Technical info on page 254
Info técnica en pág 254



0506

FIRM

ZAMAK

Designer: Frank Person

Finishes
Acabados

Textured black
Negro texturizado

| ← → | ○ — ○ |
|----------|--------|
| 93,8 mm | 64 mm |
| 125,8 mm | 96 mm |
| 189,8 mm | 160 mm |
| 349,8 mm | 320 mm |



Technical info on page 254
Info técnica en pág 254



0516

PENDANT

ZAMAK

Designer: Frank Person



Finishes
Acabados

Pewter
Peltre

Antique brass
Latón antiguo

Matt black
Negro mate

| | |
|----------|--------|
| ←→ | o — o |
| 39,3 mm | - |
| 138,4 mm | 128 mm |

⊕
Technical info on page 255
Info técnica en pág 255



0516

PENDANT

ZAMAK

Designer: Frank Person



| Finishes Acabados | ←→ | ○ — ○ |
|---------------------------------------|----------|--------|
| Pewter <i>Peltre</i> | 39,3 mm | - |
| Antique brass <i>Latón antiguo</i> | 138,4 mm | 128 mm |
| Matt black <i>Negro mate</i> | | |

⊕
Technical info on page 255
Info técnica en pág 255



0486

GRAF BIG

ALUMINIUM

Designer: Viefe®

Finishes
Acabados

Stainless steel look
Inox look

Brushed dark brass
Latón oscuro cepillado

Brushed black
Negro cepillado

| | ←→ | o — o 1 | o — o 2 |
|---|-----------|---------|---------|
| Stainless steel look <i>Inox look</i> | (Ø) 38 mm | - | - |
| | (Ø) 50 mm | - | - |
| Brushed dark brass <i>Latón oscuro cepillado</i> | 224 mm | 192 mm | - |
| | 352 mm | 320 mm | - |
| Brushed black <i>Negro cepillado</i> | 1200 mm | 1168 mm | 584 mm |



Technical info on page 256
Info técnica en pág 256



0486

GRAF BIG

ALUMINIUM

Designer: Viefef®



Finishes
Acabados

Stainless steel look
Inox look

Brushed dark brass
Latón oscuro cepillado

Brushed black
Negro cepillado



| ↳ ← | ○ — ○ 1 | ○ — ○ 2 |
|-----------|---------|---------|
| (Ø) 38 mm | - | - |
| (Ø) 50 mm | - | - |
| 224 mm | 192 mm | - |
| 352 mm | 320 mm | - |
| 1200 mm | 1168 mm | 584 mm |



Technical info on page 256
Info técnica en pág 256

0486

GRAF BIG

ALUMINIUM

Designer: Viefe®



Finishes
Acabados

Stainless steel look
Inox look

Brushed dark brass
Latón oscuro cepillado

Brushed black
Negro cepillado

| ←→ | o — o 1 | o — o 2 |
|-----------|---------|---------|
| (Ø) 38 mm | - | - |
| (Ø) 50 mm | - | - |
| 224 mm | 192 mm | - |
| 352 mm | 320 mm | - |
| 1200 mm | 1168 mm | 584 mm |



Technical info on page 256
Info técnica en pág 256



0430

GRAF MINI

ALUMINIUM

Designer: Viefé®

Finishes
Acabados

| | ←→ | ○ — ○ 1 | ○ — ○ 2 |
|---|---------|---------|---------|
| Stainless steel look <i>Inox look</i> | 10 mm | - | - |
| Brushed dark brass <i>Latón oscuro cepillado</i> | 60 mm | - | - |
| Brushed black <i>Negro cepillado</i> | 182 mm | 160 mm | - |
| | 278 mm | 256 mm | - |
| | 1200 mm | 1178 mm | 589 mm |

Includes non-twisting tip / Incluye punta anti-giro



Technical info on page 256
Info técnica en pág 256

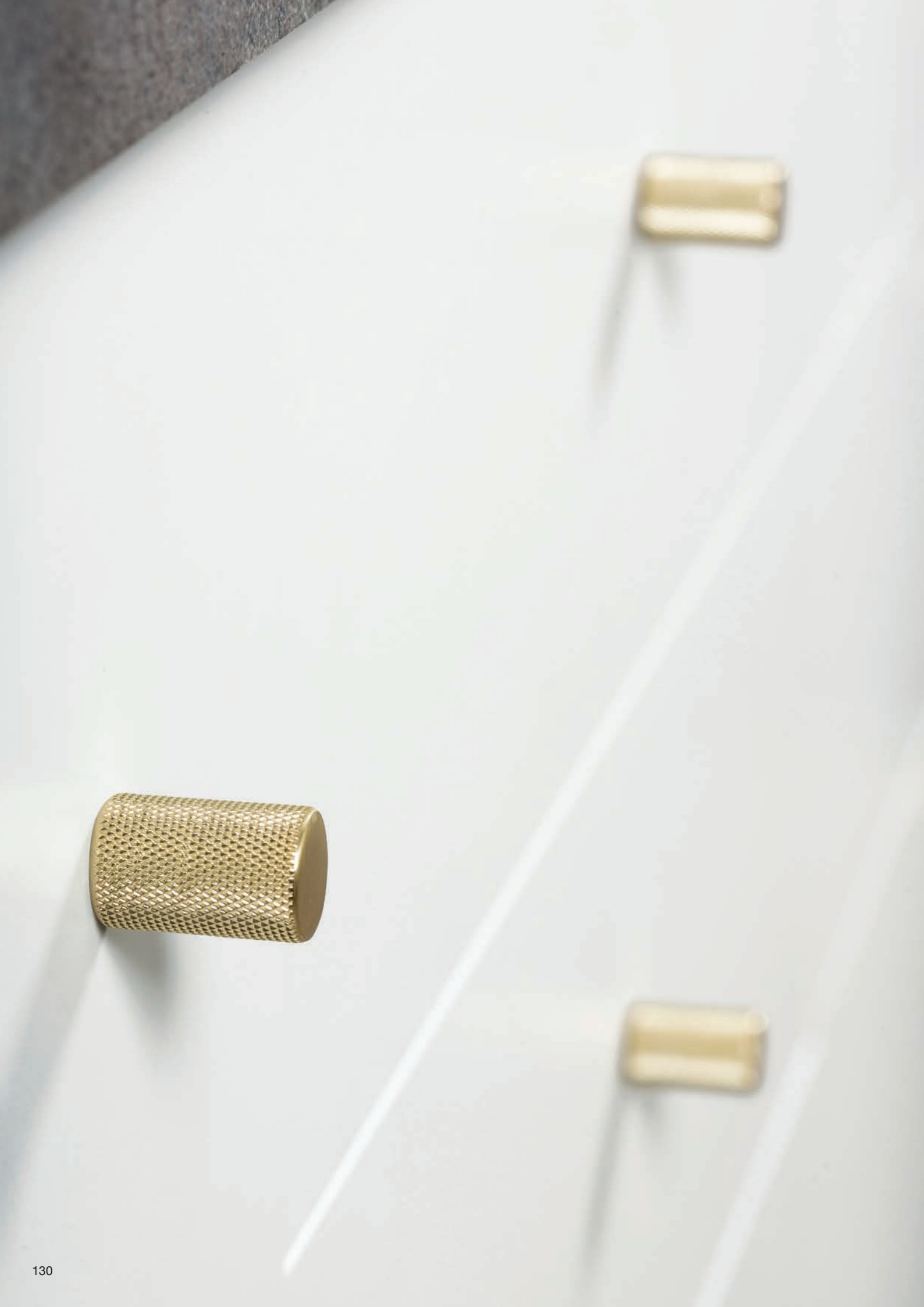

0109

GRAF

ALUMINIUM

Designer: Viefef®

Finishes
Acabados

Polished chrome
Cromo brillo

Anodized matt
Anodizado mate

Stainless steel look
Inox look

Brushed brass
Latón cepillado

Brushed dark brass
Latón oscuro cepillado

Matt black
Negro mate



17,5 mm



Technical info on page 257
Info técnica en pág 257



0459

LINES

ZAMAK

Designer: Teruel - Paré

Finishes Acabados

Brushed Níquel
Níquel cepillado

Brushed gold
Oro cepillado

Brushed mole grey
Gris topo cepillado

Matt black
Negro mate

| | |
|--------|--------|
| ←→ | o — o |
| 170 mm | 160 mm |
| 330 mm | 320 mm |



Technical info on page 252
Info técnica en pág 252



0467

SKALA

ALUMINIUM

Designer: Alexis Vivet



Finishes Acabados

Brushed black
Negro cepillado

Brushed grey
Gris cepillado

Antique bronze
Bronce antiguo

Brushed brass cava
Latón cava cepillado

|←→| o — o

200 mm

128 mm

350 mm

256 mm



Technical info on page 253
Info técnica en pág 253

0480

NICE

ZAMAK

Designer: Héctor Diego



Finishes
Acabados

Brushed Nickel
Níquel cepillado

Brushed gold
Oro cepillado

Brushed mole grey
Gris topo cepillado

Matt black
Negro mate

| | |
|----------|--------|
| ←→ | o — o |
| 184,6 mm | 160 mm |
| 344,6 mm | 320 mm |

⊕
Technical info on page 254
Info técnica en pág 254

0446

ESTE

ZAMAK

Designer: Balutto Associati



Finishes
Acabados

Polished chrome
Cromo brillo

Matt chrome
Cromo mate

Brushed nickel
Níquel cepillado

Brushed copper
Cobre cepillado

Brushed gold
Oro cepillado

Graphite grey
Gris grafito

Matt black
Negro mate

←→ | o — o
172 mm 160 mm



Technical info on page 255
Info técnica en pág 255



0447

BELLA

ZAMAK

Designer: Balutto Associati

Finishes
Acabados

Brushed copper
Cobre cepillado

Brushed gold
Oro cepillado

Graphite grey
Gris grafito

Matt black
Negro mate

←→ | o — o
176 mm 160 mm

⊕
Technical info on page 257
Info técnica en pág 257

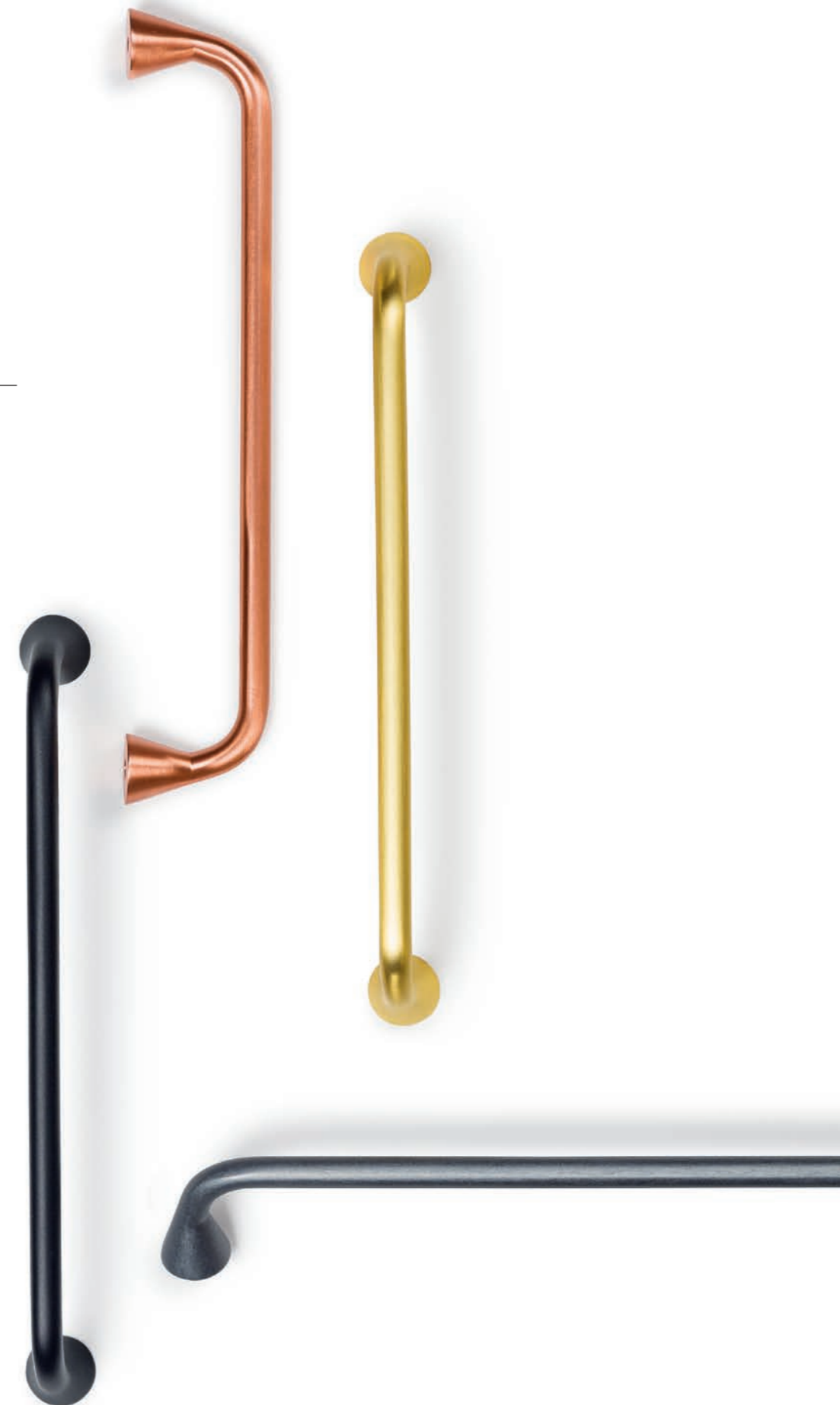



0449

HEXXA

ALUMINIUM + ZAMAK

Designer: Alexis Vivet

Finishes
Acabados

←→

| | |
|---------------------------------------|--------------------|
| Matt white <i>Blanco mate</i> | 200 mm 350 mm |
| Matt black <i>Negro mate</i> | 1100 mm 3000 mm |
| Metallic grey <i>Gris metal</i> | |
| Metallic brown <i>Marrón metal</i> | |

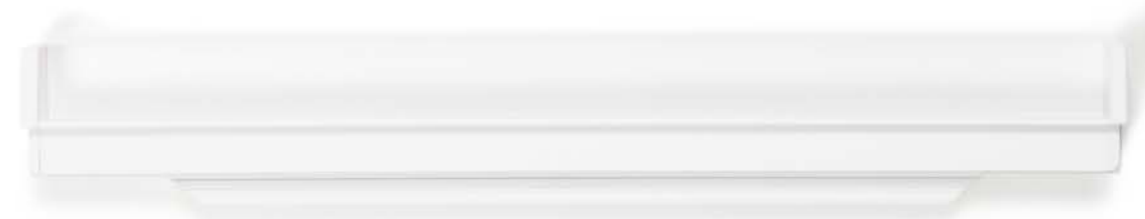

Technical info on page 258
Info técnica en pág 258

0449

HEXXA

ALUMINIUM + ZAMAK

Designer: Alexis Vivet

Finishes
Acabados

|←→|

Matt white
Blanco mate

200 mm

Matt black
Negro mate

350 mm

Metallic grey
Gris metal

1100 mm

Metallic brown
Marrón metal

3000 mm



Technical info on page 258
Info técnica en pág 258





0094

HIDE

ZAMAK

Designer: Viefe®



Finishes
Acabados

| | ←→ | o — o |
|---|-----------------|-----------------|
| Polished chrome <i>Cromo brillo</i> | 90 mm 180 mm | 64 mm 128 mm |
| Brushed nickel <i>Níquel cepillado</i> | 200 mm | 128 mm |
| Brushed gold <i>Oro cepillado</i> | | |
| Matt white <i>Blanco mate</i> | | |
| Matt black <i>Negro mate</i> | | |
| Chrome look <i>Cromo look</i> | | |

⊕
Technical info on page 258
Info técnica en pág 258



0119

WAVE

ZAMAK

Designer: Viefef®



**Finishes
Acabados**

Polished chrome
Cromo brillo
Brushed nickel
Níquel cepillado
Matt black
Negro mate

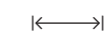

45 mm
173 mm



32 mm
160 mm



Technical info on page 259
Info técnica en pág 259



0105

(combinable with 0094)

NEST

ZAMAK

Designer: Viefef®



Finishes
Acabados

Polished chrome
Cromo brillo

Brushed nickel
Níquel cepillado

Polished chrome + White
Cromo brillo + Blanco

Brushed nickel + White
Níquel cepillado + Blanco

Matt black
Negro mate

| | |
|----------|----------|
| ←→ | ○ — ○ |
| 212,5 mm | 202,5 mm |

⊕
Technical info on page 259
Info técnica en pág 259



0235

CLOS

ZAMAK

Designer: Viefte®



Finishes

Acabados

Matt white
Blanco mate

Matt black
Negro mate

Polished chrome
Cromo brillo

Brushed nickel
Níquel cepillado



160 mm



128 mm



Technical info on page 259
Info técnica en pág 259

0366

CUBIC

ZAMAK

Designer: Viefef®



Finishes
Acabados

Matt white
Blanco mate

Matt black
Negro mate

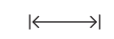

160 mm



Technical info on page 260
Info técnica en pág 260

0073

TAP

ZAMAK

Designer: Viefe®



Finishes
Acabados

Chrome look
Cromo look

Matt black
Negro mate

∅ 1

35,5 mm

55,3 mm

∅ 2

40 mm

60 mm



Technical info on page 260
Info técnica en pág 260



0301

SENSE MINI

ALUMINIUM

Designer: Viefe®



Finishes
Acabados

Polished chrome
Cromo brillo

Matt black
Negro mate

Stainless steel look
Inox look

Brushed dark brass
Latón oscuro cepillado

| ←→ | o — o |
|--------|--------|
| 103 mm | 96 mm |
| 167 mm | 160 mm |
| 263 mm | 256 mm |

⊕
Technical info on page 260
Info técnica en pág 260



0195

SENSE

ALUMINIUM

Designer: Viefef®



Finishes
Acabados

Polished chrome
Cromo brillo

Stainless steel look
Inox look

Brushed black
Negro cepillado

| | |
|--------|--------|
| ←→ | ○ — ○ |
| 135 mm | 128 mm |
| 199 mm | 192 mm |
| 327 mm | 320 mm |
| 487 mm | 480 mm |

⊕
Technical info on page 261
Info técnica en pág 261



0451

FELTRE

ZAMAK

Designer: Balutto Associati

Finishes
Acabados

Brushed nickel
Níquel cepillado

Graphite grey
Gris grafito

Matt black
Negro mate

←→ | o — o
218 mm 192 mm

⊕
Technical info on page 257
Info técnica en pág 257



0452

BRAVE

ALUMINIUM

Designer: Viefe®



Finishes
Acabados

Matt white
Blanco mate

Matt black
Negro mate

Metallic grey
Gris metal

Metallic brown
Marrón metal

| ↳—→ | ○ — ○ 1 | ○ — ○ 2 |
|---------|---------|---------|
| 160 mm | 128 mm | - |
| 240 mm | 192 mm | - |
| 400 mm | 320 mm | - |
| 600 mm | 192 mm | 480 mm |
| 1040 mm | 192 mm | 992 mm |
| 1150 mm | 192 mm | 1120 mm |



Technical info on page 263
Info técnica en pág 263

0444

PEAK

ALUMINIUM

Designer: Viefe©



Finishes
Acabados

Stainless steel look
Inox look

Brushed black
Negro cepillado

Matt white
Blanco mate

Metallic grey
Gris metal

Metallic brown
Marrón metal

| ←→ | o — o 1 | o — o 2 |
|---------|---------|---------|
| 120 mm | 64 mm | - |
| 250 mm | 192 mm | 160 mm |
| 500 mm | 448 mm | 160 mm |
| 800 mm | 768 mm | 160 mm |
| 1150 mm | 1120 mm | 160 mm |
| 1800 mm | 1760 mm | 160 mm |

⊕
Technical info on page 264
info técnica en pág 264



0444

PEAK

ALUMINIUM

Designer: Viefef®



Finishes
Acabados

Stainless steel look
Inox look

Brushed black
Negro cepillado

Matt white
Blanco mate

Metallic grey
Gris metal

Metallic brown
Marrón metal

| | ←→ | o — o 1 | o — o 2 |
|--|---------|---------|---------|
| Stainless steel look <i>Inox look</i> | 120 mm | 64 mm | - |
| Brushed black <i>Negro cepillado</i> | 250 mm | 192 mm | 160 mm |
| Matt white <i>Blanco mate</i> | 500 mm | 448 mm | 160 mm |
| Metallic grey <i>Gris metal</i> | 800 mm | 768 mm | 160 mm |
| Metallic brown <i>Marrón metal</i> | 1150 mm | 1120 mm | 160 mm |
| | 1800 mm | 1760 mm | 160 mm |

⊕
Technical info on page 264
Info técnica en pág 264



0341

ASI

ALUMINIUM

Designer: Oriol Barri



Finishes
Acabados

Matt black
Negro mate

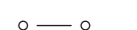
|  |  |
|---|---|
| 146 mm | 128 mm |
| 210 mm | 192 mm |
| 338 mm | 320 mm |

 Technical info on page 262
Info técnica en pág 262



0375

VANN

ALUMINIUM

Designer: Alexis Vivet



Finishes
Acabados

Anodized bright
Anodizado brillo

Anodized matt
Anodizado mate

Matt black
Negro mate

Stainless steel look
Inox look

Brushed dark brass
Latón oscuro cepillado

| | ◀—▶ | ○ — ○ 1 | ○ — ○ 2 |
|----------------------|---------|---------|---------|
| Anodized bright | 100 mm | 64 mm | - |
| Anodized matt | 200 mm | 128 mm | - |
| Matt black | 350 mm | 256 mm | - |
| Stainless steel look | 1200 mm | 1120 mm | 384mm |

⊕
Technical info on page 266
Info técnica en pág 266



Finishes Acabados

Anodized bright
Anodizado brillo

Anodized matt
Anodizado mate

Matt black
Negro mate

Stainless steel look
Inox look

Brushed dark brass
Latón oscuro cepillado

| ←→ | ○ — ○ 1 | ○ — ○ 2 |
|---------|---------|---------|
| 100 mm | 64 mm | - |
| 200 mm | 128 mm | - |
| 350 mm | 256 mm | - |
| 1200 mm | 1120 mm | 384mm |



Technical info on page 266
Info técnica en pág 266

0117

CURVE

ALUMINIUM

Designer: Viefe®

Finishes Acabados

Anodized matt
Anodizado mate

Stainless steel look
Inox look

Brushed grey
Gris cepillado

Matt white
Blanco mate

Matt black
Negro mate

| ←→ | o — o |
|--------|--------|
| 45 mm | 32 mm |
| 100 mm | 64 mm |
| 200 mm | 128 mm |
| 300 mm | 192 mm |
| 400 mm | 320 mm |
| 500 mm | 416 mm |



Technical info on page 267
Info técnica en pág 267

0139 / 0140

LINEAR

ALUMINIUM

Designer: Viefte®



Finishes
Acabados

Stainless steel look
Inox look

Brushed black
Negro cepillado

←→

147 mm

197 mm

247 mm

297 mm

347 mm

397 mm

447 mm

497 mm

597 mm

697 mm

797 mm

897 mm

997 mm

1197 mm



Technical info on page 267
Info técnica en pág 267

0434 / 0435 / 0436

VECTOR

ALUMINIUM

Designer: Viefè®



Finishes
Acabados

Stainless steel look
Inox look

Brushed black
Negro cepillado

Brushed grey
Gris cepillado

←→

147 mm

197 mm

247 mm

297 mm

347 mm

397 mm

447 mm

497 mm

597 mm

697 mm

797 mm

897 mm

997 mm

1197 mm

⊕
Technical info on page 268
Info técnica en pág 268

0379 / 0380 / 0382

STEEP

ALUMINIUM

Designer: Viefef®

Finishes
Acabados

Anodized bright
Anodizado brillo

Stainless steel look
Inox look

Matt black
Negro mate



3000 mm



Technical info on page 270
Info técnica en pág 270

0250 / 0251 / 0253

FORMA

ALUMINIUM

Designer: 2J Design



147 mm

197 mm

247 mm

297 mm

347 mm

397 mm

447 mm

497 mm

597 mm

697 mm

797 mm

897 mm

997 mm

1197 mm

Finishes
Acabados

Stainless steel look
Inox look



Technical info on page 269
Info técnica en pág 269

0334

BRIKK

ALUMINIUM

Designer: Alexis Vivet

**Finishes
Acabados**

| | ←→ | ○ — ○ 1 | ○ — ○ 2 | ○ — ○ 3 |
|---------|--------|---------|---------|---------|
| 140 mm | 32 mm | - | - | - |
| 190 mm | 64 mm | - | - | - |
| 240 mm | 96 mm | - | - | - |
| 290 mm | 160 mm | - | - | - |
| 340 mm | 192 mm | - | - | - |
| 390 mm | 128 mm | 260 mm | - | - |
| 440 mm | 160 mm | 310 mm | - | - |
| 490 mm | 192 mm | 360 mm | - | - |
| 590 mm | 224 mm | 460 mm | - | - |
| 690 mm | 256 mm | 560 mm | - | - |
| 790 mm | 320 mm | 660 mm | - | - |
| 890 mm | 384 mm | 760 mm | - | - |
| 990 mm | 320 mm | 640 mm | 860 mm | - |
| 1190 mm | 320 mm | 832 mm | 1060 mm | - |



Technical info on page 269
Info técnica en pág 269



0311

TAMM

ALUMINIUM

Designer: Alexis Vivet



| Finishes Acabados | ←→ | ○ — ○ 1 | ○ — ○ 1/2 | ○ — ○ 2 | ○ — ○ 3 |
|--|---------|---------|-----------|---------|---------|
| Stainless steel look <i>Inox look</i> | 140 mm | 32 mm | - | - | - |
| | 190 mm | 64 mm | - | - | - |
| | 240 mm | 128 mm | - | - | - |
| | 290 mm | 160 mm | - | 174 mm | - |
| | 340 mm | 192 mm | - | 224 mm | - |
| | 390 mm | 256 mm | 128 mm | 274 mm | - |
| | 440 mm | 256 mm | 128 mm | 324 mm | - |
| | 490 mm | 320 mm | 160 mm | 374 mm | - |
| | 590 mm | 448 mm | 224 mm | 474 mm | - |
| | 690 mm | 512 mm | 256 mm | 574 mm | - |
| | 790 mm | 224 mm | - | 608 mm | 674 mm |
| | 890 mm | 320 mm | - | 704 mm | 774 mm |
| | 990 mm | 320 mm | - | 832 mm | 874 mm |
| | 1190 mm | 384 mm | - | 1024 mm | 1074 mm |



Technical info on page 263
Info técnica en pág 263

0343

GRADA

ALUMINIUM

Designer: Viefe®

**Finishes
Acabados**

|←→|

| | |
|--|---------|
| Anodized matt <i>Anodizado mate</i> | 147 mm |
| | 197 mm |
| Stainless steel look <i>Inox look</i> | 247 mm |
| | 297 mm |
| Matt white <i>Blanco mate</i> | 347 mm |
| | 397 mm |
| Matt black <i>Negro mate</i> | 447 mm |
| | 497 mm |
| Anodized bright <i>Anodizado brillo</i> | 597 mm |
| | 697 mm |
| | 797 mm |
| | 897 mm |
| | 997 mm |
| | 1197 mm |
| | 3000 mm |



Technical info on page 270
Info técnica en pág 270



0053

DINO

ZAMAK

Designer: Viefef®



Finishes
Acabados

Polished chrome
Cromo brillo

Brushed nickel
Niquel cepillado

Matt white
Blanco mate

Matt black
Negro mate

Aluminium look
Aluminio look

| ←→ | o — o 1 | o — o 2 |
|--------|---------|---------|
| 156 mm | 96 mm | 128 mm |
| 221 mm | 160 mm | 192 mm |
| 349 mm | 288 mm | 320 mm |

⊕
Technical info on page 264
Info técnica en pág 264



0373

NICK

ZAMAK

Designer: Alexis Vivet



Finishes
Acabados

Polished chrome
Cromo brillo

Brushed nickel
Níquel cepillado

Brushed copper
Cobre cepillado

Brushed brass
Latón cepillado

| | |
|--------|--------|
| ◀—▶ | ○ — ○ |
| 50 mm | 32 mm |
| 178 mm | 160 mm |

⊕
Technical info on page 261
Info técnica en pág 261

0322

CUTT

ALUMINIUM

Designer: Alexis Vivet

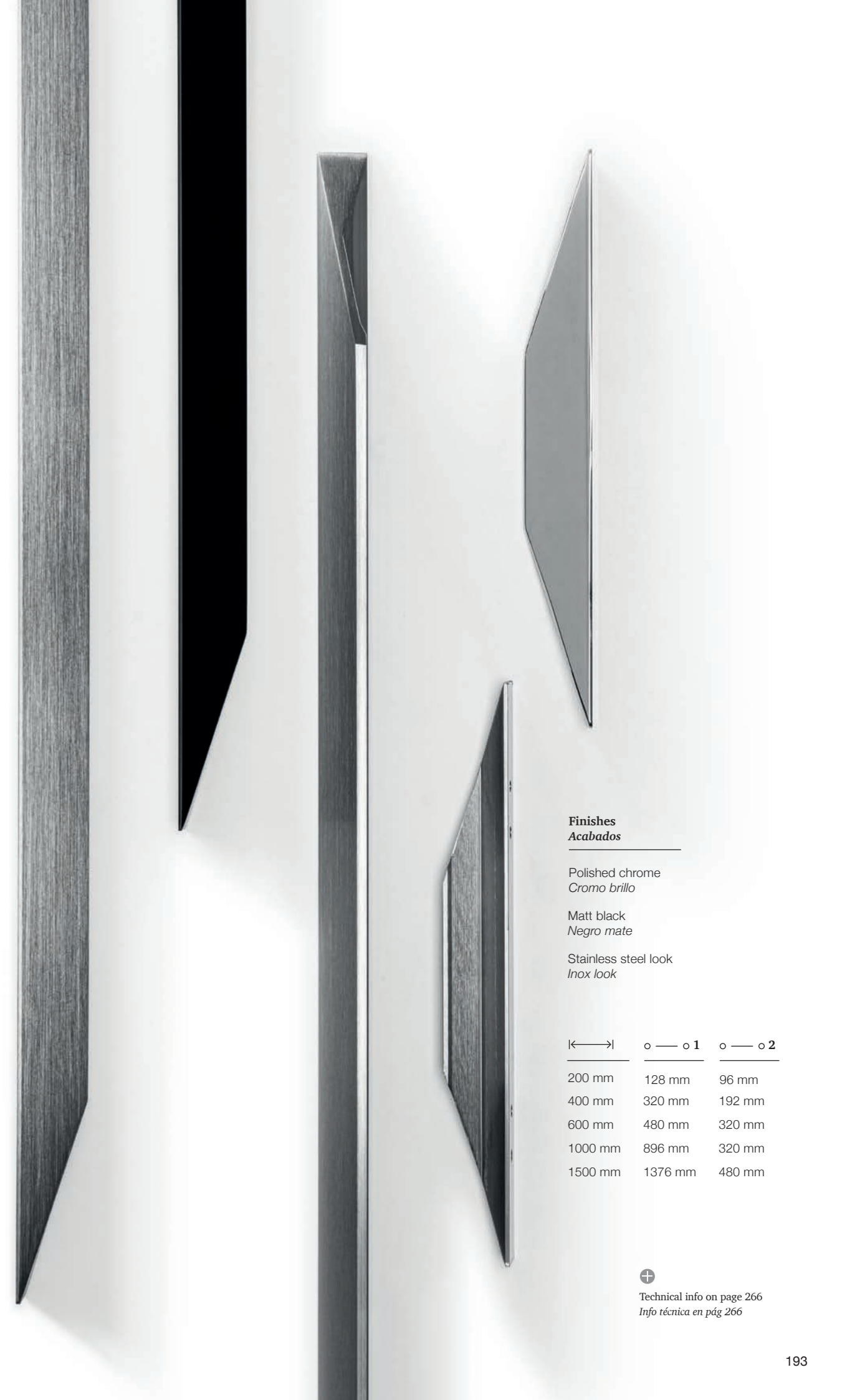

Finishes
Acabados

Polished chrome
Cromo brillo

Matt black
Negro mate

Stainless steel look
Inox look

| $\overline{\text{K}} \rightarrow \text{L}$ | $\circ \text{---} \circ 1$ | $\circ \text{---} \circ 2$ |
|--|----------------------------|----------------------------|
| 200 mm | 128 mm | 96 mm |
| 400 mm | 320 mm | 192 mm |
| 600 mm | 480 mm | 320 mm |
| 1000 mm | 896 mm | 320 mm |
| 1500 mm | 1376 mm | 480 mm |



Technical info on page 266
Info técnica en pág 266

0108

TWISTED

ZAMAK

Designer: Viefé®



Finishes
Acabados

Polished chrome
Cromo brillo

Brushed nickel
Níquel cepillado



170 mm
234 mm
340 mm



160 mm
224 mm
320 mm



Technical info on page 271
Info técnica en pág 271



0239

ARA

ALUMINIUM

Designer: 2J Design



Finishes
Acabados

Stainless steel look
Inox look



156 mm
252 mm
380 mm



96 mm
192 mm
320 mm



Technical info on page 271
Info técnica en pág 271



0410

BUTTON

ZAMAK

Designer: Alexis Vivet



Finishes

Acabados

Polished chrome
Cromo brillo

Pewter
Peltre

Antique Brass
Latón antiguo

Matt black
Negro mate



175 mm

160 mm



Technical info on page 272
Info técnica en pág 272



0393

DUKE

ZAMAK

Designer: Viefef®



Finishes
Acabados

Antique copper
Cobre antiguo

Antique silver
Plata antigua

Matt black
Negro mate

Matt white
Blanco mate

Pewter
Peltre

Antique Brass
Latón antiguo

Polished chrome
Cromo brillo

Brushed nickel
Níquel cepillado

Brushed brass
Latón cepillado

Brushed copper
Cobre cepillado



31,4 mm



Technical info on page 272
Info técnica en pág 272

0226

REDO

ZAMAK

Designer: 2J Design

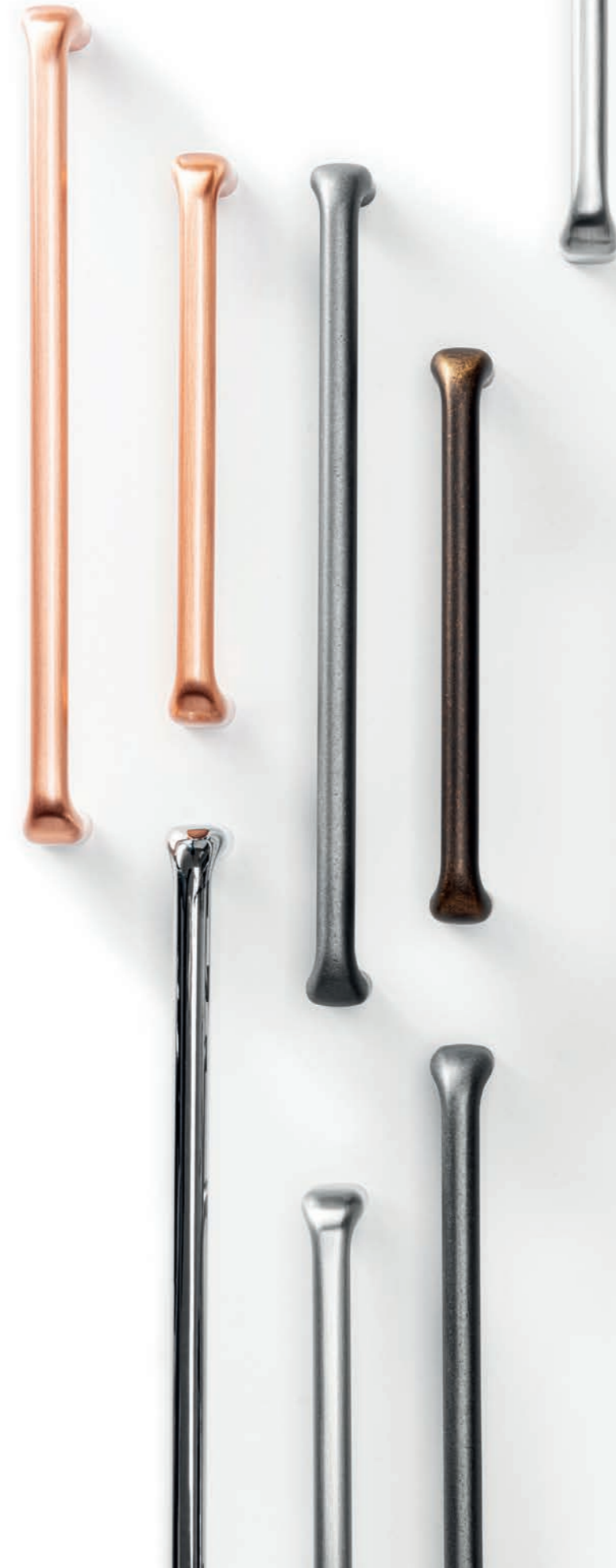

Finishes
Acabados

Antique Brass
Latón antiguo

Polished chrome
Cromo brillo

Brushed nickel
Níquel cepillado

Brushed copper
Cobre cepillado

Pewter
Peltre

←→

o — o

137 mm

128 mm

201 mm

192 mm



Technical info on page 273
Info técnica en pag 273



0411

VERSO

ZAMAK

Designer: Teruel & Paré



**Finishes
Acabados**

Polished chrome
Cromo brillo

Brushed nickel
Níquel cepillado

Pewter
Peltre

Antique Brass
Latón antiguo

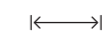

15 mm
224 mm

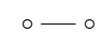

-
192 mm



Technical info on page 273
Info técnica en pág 273



0405

RAVIOLO

ZAMAK

Designer: Balutto Associati



Finishes
Acabados

Pewter
Peltre

Antique Brass
Latón antiguo

← →

Ø 29 mm

172 mm

○ — ○

-

96 mm



Technical info on page 273
Info técnica en pág 273

0394

AVA

ZAMAK

Designer: Viefie®



0390

PETRA

ZAMAK

Designer: Viefie®



Finishes
Acabados

Pewter
Peltre

Antique Brass
Latón antiguo

Polished Chrome
Cromo brillo

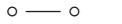

 128,5 mm 96 mm





 Technical info on page 274
Info técnica en pág 274

Finishes
Acabados

Antique copper
Cobre antiguo

Antique silver
Plata antigua

Matt black
Negro mate



 97 mm 64 mm



 Technical info on page 274
Info técnica en pág 274

0392

ORION

ZAMAK

Designer: Viefte®



Finishes
Acabados

Antique copper
Cobre antiguo

Antique silver
Plata antigua



136 mm



128 mm



Technical info on page 274
Info técnica en pág 274

0391

AURA

ZAMAK

Designer: Viefte®



Finishes
Acabados

Antique copper
Cobre antiguo

Antique silver
Plata antigua



87 mm



64 mm



Technical info on page 275
Info técnica en pág 275





Finishes
Acabados

Polished chrome + Beige / Brown / Black
Cromo brillo + Beige / Marrón / Negro

Pewter + Beige / Brown / Black
Peltre + Beige / Marrón / Negro

Matt black + Beige / Brown / Black
Negro mate + Beige / Marrón / Negro

Brushed brass + Beige / Brown / Black
Latón cepillado + Beige / Marrón / Negro

| | |
|--------|--------|
| ←→ | ○ — ○ |
| 70 mm | - |
| 150 mm | 128 mm |
| 182 mm | 160 mm |



⊕
Technical info on page 275
Info técnica en pág 275

0239

ARA W

ALUMINIUM + WOOD

Designer: 2J Design



Finishes
Acabados

Stainless steel look + Oak
Inox look + Roble

Stainless steel look + Walnut
Inox look + Nogal



220 mm
284 mm



160 mm
224 mm



Technical info on page 276
Info técnica en pág 276



0340

BARCCO

WOOD

Designer: Alexis Vivet



Finishes
Acabados

Ash
Fresno

Walnut
Nogal

Beech raw
Haya crudo

| K → | o — o 1 | o — o 2 |
|--------|---------|---------|
| 200 mm | 160 mm | - |
| 400 mm | 320 mm | - |
| 600 mm | 320 mm | 480 mm |

⊕
Technical info on page 276
Info técnica en pág 276

0165

CALIN

WOOD

Designer: Viefefo



0326

TACCO

WOOD

Designer: Alexis Vivet





Finishes
Acabados

Raw brushed
Crudo cepillado

White brushed
Blanco cepillado

Brown brushed
Marrón cepillado

Black brushed
Negro cepillado

 
 240 mm 160 mm





 Technical info on page 276
Info técnica en pág 276

Finishes
Acabados

Ash
Fresno

Walnut
Nogal

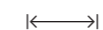
Beech raw
Haya crudo

 
 92,3 mm 32 mm



 Technical info on page 277
Info técnica en pág 277

0166

ECHO

WOOD

Designer: Viefef®



Finishes Acabados

Raw brushed
Crudo cepillado

White brushed
Blanco cepillado

Brown brushed
Marrón cepillado

Black brushed
Negro cepillado



60 mm



Technical info on page 277
Info técnica en pág 277

0167

BALTO

WOOD

Designer: Viefef®



Finishes Acabados

Raw brushed
Crudo cepillado

White brushed
Blanco cepillado

Brown brushed
Marrón cepillado

Black brushed
Negro cepillado



60 mm

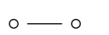

16 mm



Technical info on page 277
Info técnica en pág 277



0281

FLAT

ZAMAK

Designer: Oriol Barri



Finishes
Acabados

Polished chrome
Cromo brillo

Brushed nickel
Níquel cepillado

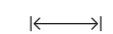

174,8 mm

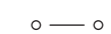

160 mm



Technical info on page 278
Info técnica en pág 278

0243 ST

LOW ST

ZAMAK

Designer: Viefie®



Finishes
Acabados

Polished chrome
Cromo brillo

Brushed nickel
Niquel cepillado

| | |
|--------|--------|
| ←→ | ○ — ○ |
| 78 mm | 64 mm |
| 206 mm | 192 mm |

⊕
Technical info on page 278
Info técnica en pág 278

0204

RADI

STAINLESS STEEL

Designer: Viefie®



Finishes
Acabados

Brushed stainless steel
Inox cepillado



50 mm
65 mm

⊕
Technical info on page 278
Info técnica en pág 278

0208

DUA

ZAMAK

Designer: 2J Design



Finishes
Acabados

Polished chrome
Cromo brillo
Brushed nickel
Níquel cepillado



210 mm



192 mm

⊕
Technical info on page 279
Info técnica en pág 279



0374

BALL

ZAMAK

Designer: Alexis Vivet



Finishes
Acabados

Polished chrome
Cobre brillo
Brushed nickel
Níquel cepillado
Brushed brass
Latón cepillado



23,3 mm
29,5 mm

⊕
Technical info on page 272
Info técnica en pág 272

0376

BOXX

ZAMAK

Designer: Alexis Vivet



Finishes
Acabados

Polished chrome
Cromo brillo

Matt chrome
Cromo mate

Brushed nickel
Níquel cepillado

Matt black
Negro mate



15 mm



Technical info on page 279
Info técnica en pág 279

0315

ZAPA

ZAMAK

Designer: Oriol Barri



Finishes Acabados

Polished chrome
Cromo brillo

Matt chrome
Cromo mate

Brushed nickel
Níquel cepillado



45 mm

Includes non-twisting tip
Incluye punta anti-giro



Technical info on page 282
Info técnica en pág 282

0219

ARROW

ZAMAK

Designer: 2J Design



0114

HOOK

ZAMAK

Designer: 2J Design



Finishes Acabados

Polished chrome
Cromo brillo

Brushed nickel
Níquel cepillado

Includes non-twisting tip
Incluye punta anti-giro



30 mm



Technical info on page 282
Info técnica en pág 282



Finishes Acabados

Polished chrome
Cromo brillo

Brushed nickel
Níquel cepillado



223 mm



192 mm



Technical info on page 271
Info técnica en pág 271

0369

RITTA

ALUMINIUM

Designer: Teruel-Paré



Finishes
Acabados

Polished chrome
Cromo brillo

Matt black
Negro mate

Stainless steel look
Inox look

| ←→ | ○ — ○ |
|--------|--------|
| 130 mm | 64 mm |
| 260 mm | 128 mm |

⊕
Technical info on page 280
Info técnica en pág 280

0092

GLASS

ZAMAK + GLASS

Designer: Viefef®



Finishes
Acabados

Polished chrome + Tempered glass
Cromo brillo + Cristal temperado

| ←→ | ○ — ○ |
|--------|--------|
| 30 mm | - |
| 175 mm | 160 mm |
| 207 mm | 192 mm |
| 335 mm | 320 mm |

⊕
Technical info on page 280
Info técnica en pág 280

0249

FERRI

STAINLESS STEEL

Designer: Viefef®



Finishes
Acabados

Brushed stainless steel
Acero inoxidable cepillado

| ←→ | ○ — ○ |
|--------|--------|
| 140 mm | 128 mm |
| 172 mm | 160 mm |
| 204 mm | 192 mm |
| 332 mm | 320 mm |
| 524 mm | 512 mm |

⊕
Technical info on page 280
Info técnica en pág 280

0076

FORT

STAINLESS STEEL

Designer: Viefef®



Finishes
Acabados

Brushed stainless steel
Inox cepillado

| ←→ | ○ — ○ |
|--------|--------|
| 143 mm | 128 mm |
| 175 mm | 160 mm |
| 207 mm | 192 mm |
| 271 mm | 256 mm |
| 335 mm | 320 mm |
| 407 mm | 392 mm |
| 507 mm | 492 mm |
| 607 mm | 592 mm |
| 707 mm | 692 mm |

⊕
Technical info on page 281
Info técnica en pág 281

0206

ARCH

ZAMAK

Designer: 2J Design

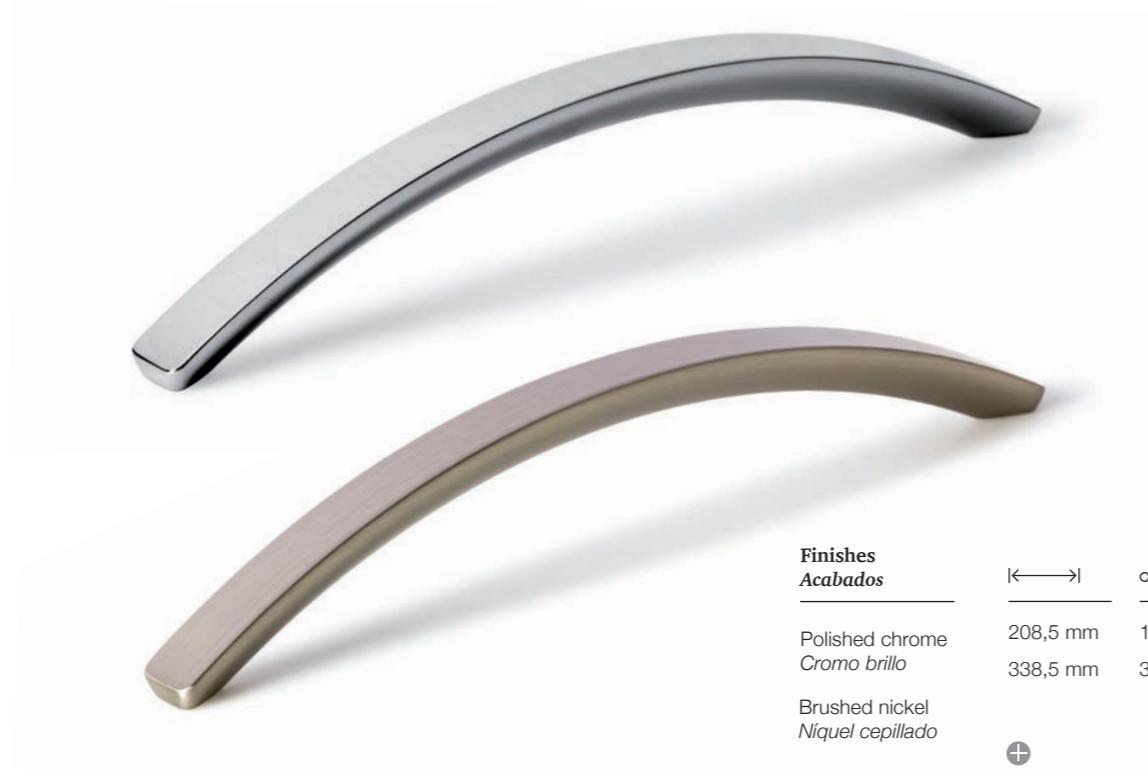

**Finishes
Acabados**

| | ←→ | ○ — ○ |
|---|----------|--------|
| Polished chrome <i>Cromo brillo</i> | 208,5 mm | 192 mm |
| Brushed nickel <i>Níquel cepillado</i> | 338,5 mm | 320 mm |

⊕
Technical info on page 265
Info técnica en pág 265

0064

KOMBI

STAINLESS STEEL

Designer: Viefef®



**Finishes
Acabados**

| | ←→ | ○ — ○ |
|--|---------|---------|
| Brushed stainless steel <i>Inox cepillado</i> | 182 mm | 160 mm |
| | 214 mm | 192 mm |
| | 314 mm | 292 mm |
| | 364 mm | 342 mm |
| | 414 mm | 392 mm |
| | 514 mm | 492 mm |
| | 814 mm | 792 mm |
| | 1114 mm | 1092 mm |

⊕
Technical info on page 281
Info técnica en pág 281

0162

KADO

ZAMAK

Designer: Viefef®

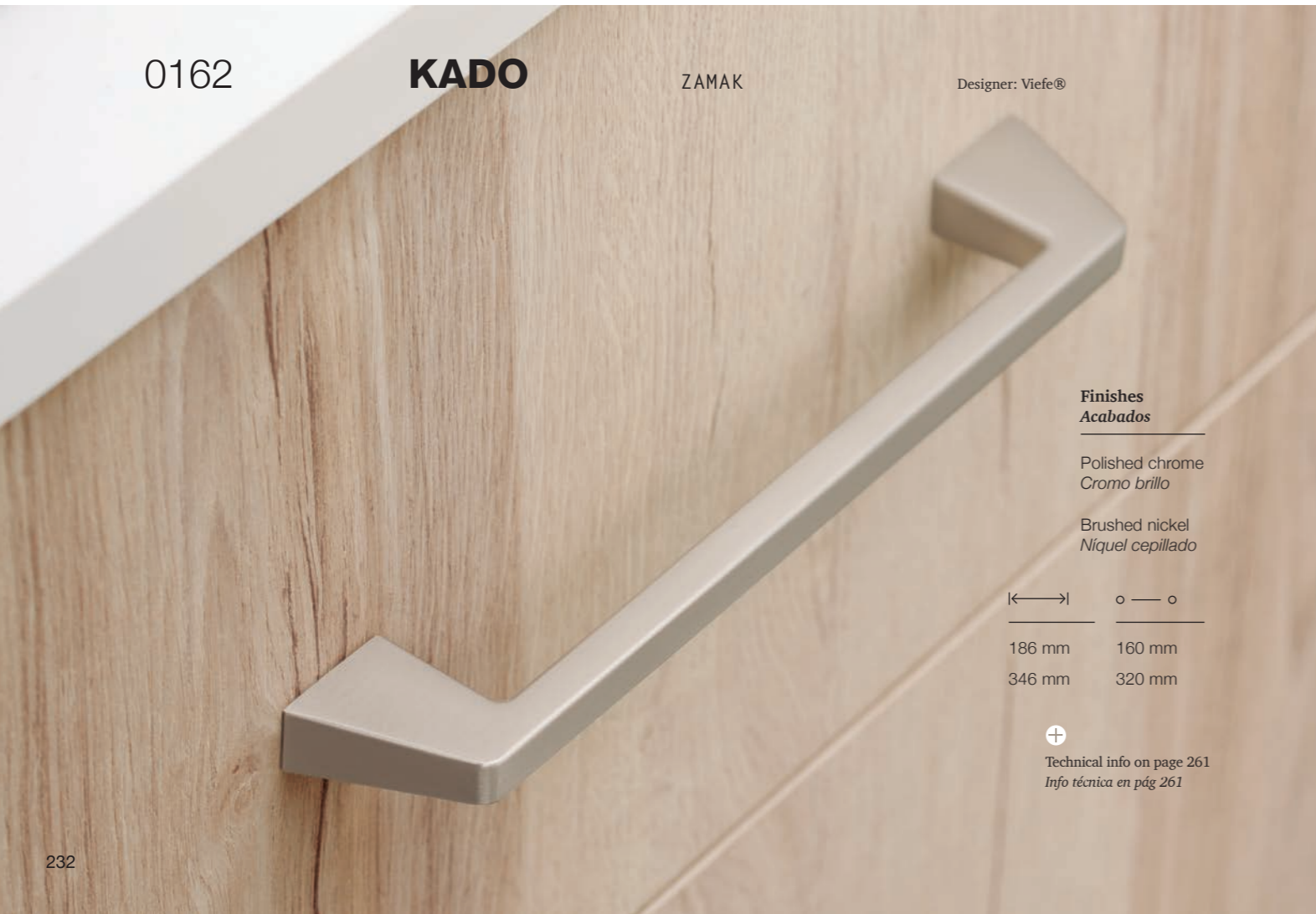

**Finishes
Acabados**

- Polished chrome
Cromo brillo
- Brushed nickel
Níquel cepillado

| | ←→ | ○ — ○ |
|--|--------|--------|
| | 186 mm | 160 mm |
| | 346 mm | 320 mm |

⊕
Technical info on page 261
Info técnica en pág 261

0035

ACER

STAINLESS STEEL

Designer: 2J Design

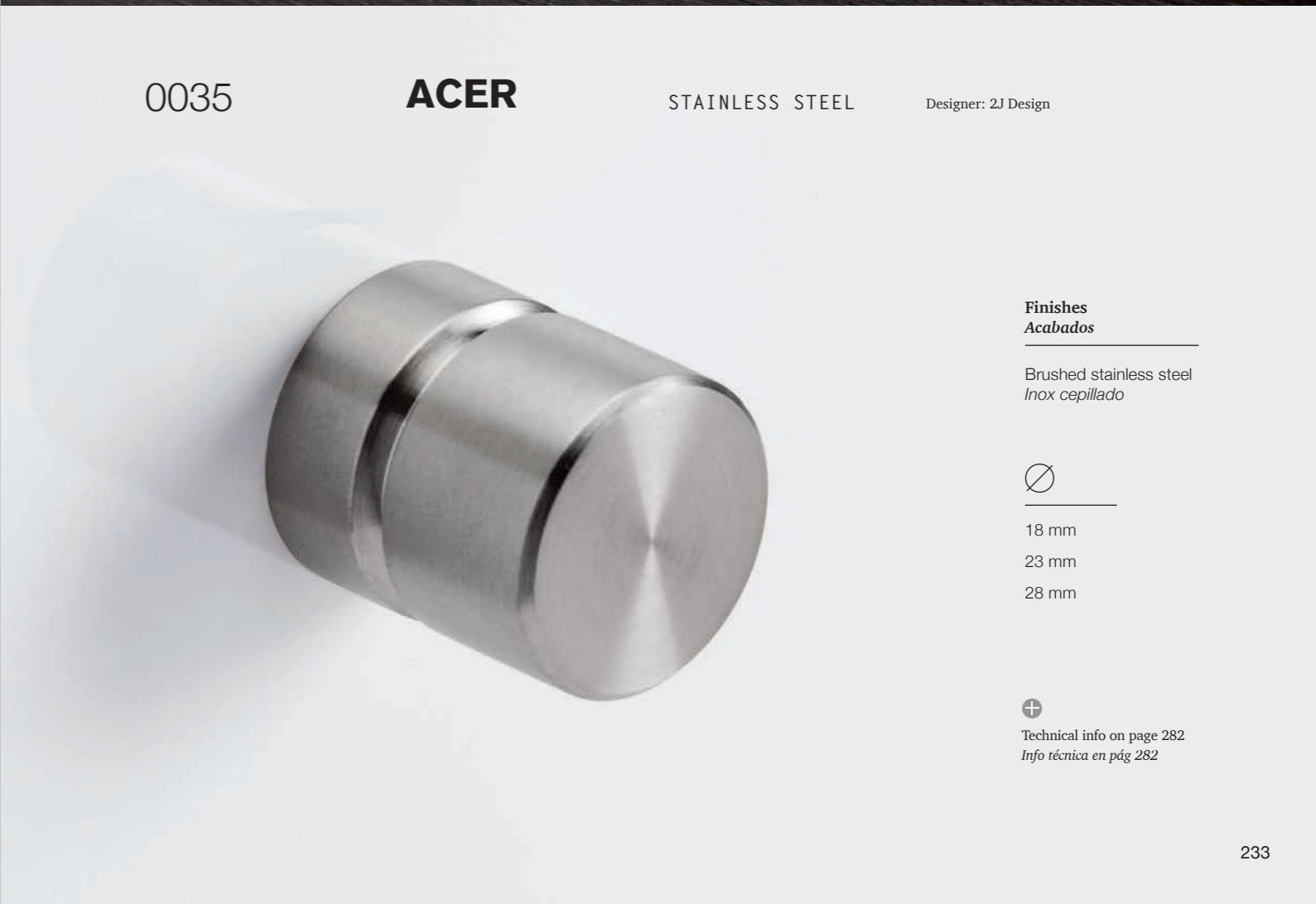

**Finishes
Acabados**

- Brushed stainless steel
Inox cepillado

| ∅ |
|-------|
| 18 mm |
| 23 mm |
| 28 mm |

⊕
Technical info on page 282
Info técnica en pág 282

0091

RASO

ZAMAK

Designer: Viefte®



Finishes
Acabados

Brushed nickel
Níquel cepillado

| | |
|----------|--------|
| | |
| 70 mm | 32 mm |
| 152,5 mm | 108 mm |



Technical info on page 279
Info técnica en pág 279

0312

ARKO

ALUMINIUM

Designer: Viefte®



Finishes
Acabados

Stainless steel look
Inox look

| | |
|--------|--------|
| | |
| 186 mm | 160 mm |
| 218 mm | 192 mm |
| 292 mm | 256 mm |



Technical info on page 281
Info técnica en pág 281

6003

JAZZ

ALUMINIUM

Designer: Viefte®

Finishes
Acabados

Polished chrome
Cromo brillo

Chrome look
Cromo look

| |
|-------|
| |
| 91 mm |



Technical info on page 283
Info técnica en pág 283

6005

FONDA

ALUMINIUM

Designer: Viefe®



Finishes
Acabados

| | ↕ |
|---|--------|
| Polished chrome <i>Cromo brillo</i> | 100 mm |
| Stainless steel look <i>Inox look</i> | 150 mm |
| Brushed dark brass <i>Latón oscuro cepillado</i> | 200 mm |
| Brushed black <i>Negro cepillado</i> | |

⊕
Technical info on page 283
Info técnica en pág 283

Viefe[®]

TECHNICAL INFO

—
INFORMACIÓN
TÉCNICA

—
INFORMACIÓ
TÈCNICA

20
22

0528 **RILLE** ALUMINIUM Design: Patricia Roig **NEW!**

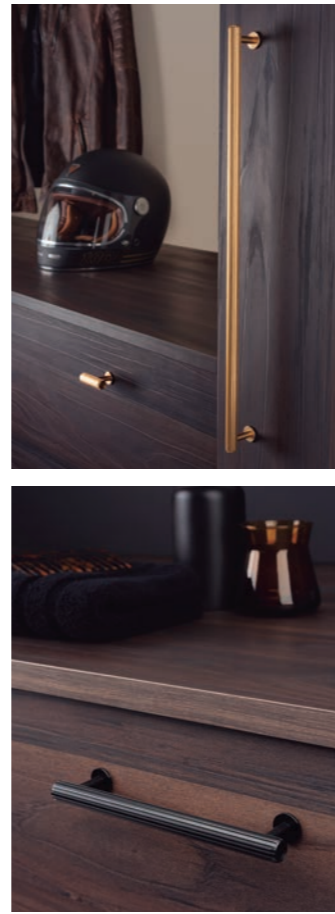
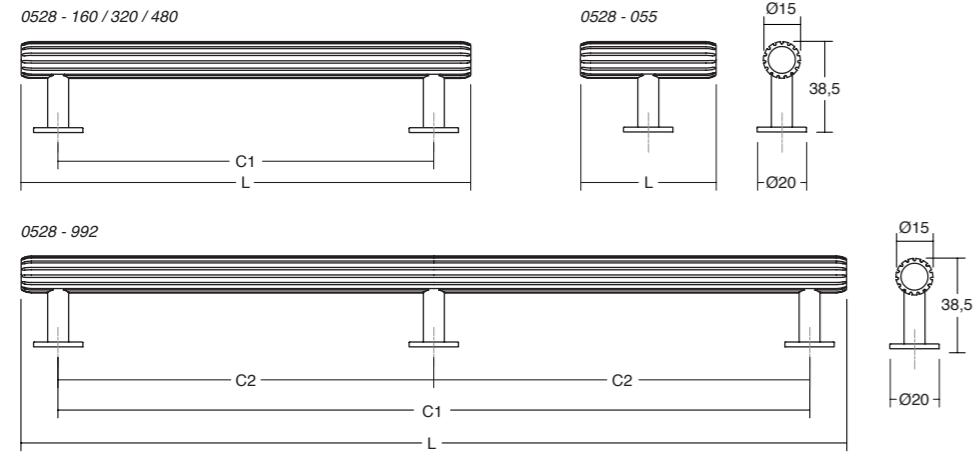

| 24 Stainless steel look Inox look | 291 Brushed dark brass Latón oscuro cepillado | 30 Brushed black Negro cepillado | C1 | C2 | L | ↓ | ☐ |
|---|---|--|-----|-----|------|---|----|
| 0528055L24 | 0528055L291 | 0528055L30 | - | - | 55 | 1 | 25 |
| 0528160L24 | 0528160L291 | 0528160L30 | 160 | - | 190 | 2 | 25 |
| 0528320L24 | 0528320L291 | 0528320L30 | 320 | - | 350 | 2 | 25 |
| 0528480L24 | 0528480L291 | 0528480L30 | 480 | - | 510 | 2 | 25 |
| 0528992L24 | 0528992L291 | 0528992L30 | 992 | 496 | 1022 | 3 | 15 |

0530 **DISC** WOOD Design: Balutto Associati **NEW!**

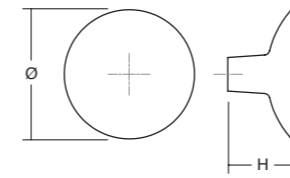

| 16 Oak Roble | 17 Walnut Nogal | M2 Matt black lacquered Negro mate lacado | Ø | H | ↓ | ☐ |
|--------------------|-----------------------|---|----|------|---|----|
| 0530038W16 | 0530038W17 | 0530038WM2 | 38 | 20,4 | 1 | 25 |
| 0530050W16 | 0530050W17 | 0530050WM2 | 50 | 27 | 1 | 25 |

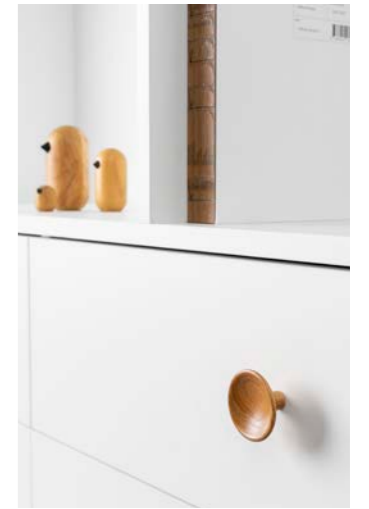

0530 **DISC** ZAMAK Design: Balutto Associati **NEW!**

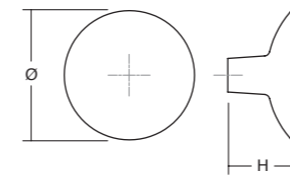

| 23 Brushed nickel Níquel cepillado | 620 Brass Latón | M1 Matt white Blanco mate | M2 Matt black Negro mate | Ø | H | ↓ | ☐ |
|--|-----------------------|---------------------------------|--------------------------------|----|------|---|----|
| 0530038Z23 | 0530038Z620 | 0530038ZM1 | 0530038ZM2 | 38 | 20,4 | 1 | 25 |
| 0530050Z23 | 0530050Z620 | 0530050ZM1 | 0530050ZM2 | 50 | 27 | 1 | 25 |

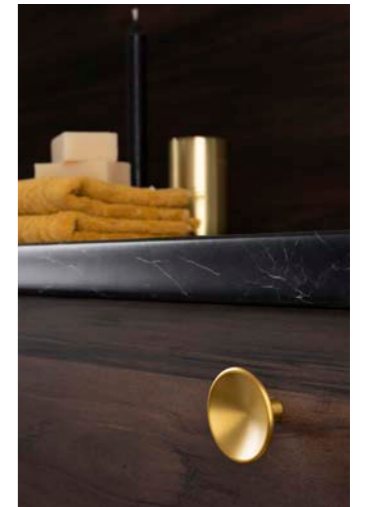

0536 **LUV** ZAMAK Design: Kaschkasch **NEW!**

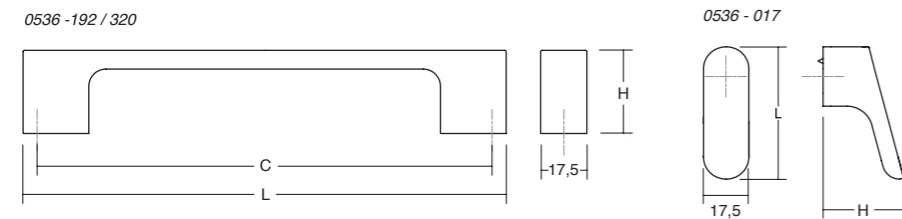

| 23 Brushed nickel Níquel cepillado | 620 Brass Latón | M1 Matt white Blanco mate | M2 Matt black Negro mate | C | L | H | ↓ | ☐ |
|--|-----------------------|---------------------------------|--------------------------------|-----|------|------|---|----|
| 0536017Z23 | 0536017Z620 | 0536017ZM1 | 0536017ZM2 | - | 51,2 | 31,1 | 1 | 25 |
| 0536192Z23 | 0536192Z620 | 0536192ZM1 | 0536192ZM2 | 192 | 202 | 30,4 | 2 | 25 |
| 0536320Z23 | 0536320Z620 | 0536320ZM1 | 0536320ZM2 | 320 | 330 | 30,4 | 2 | 25 |

Includes non-twisting tip / Incluye punta anti-giro

0538 **CONIC** WOOD Design: Kaschkasch **NEW!**

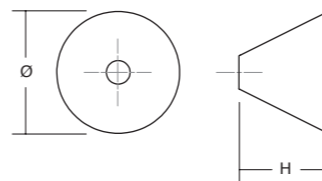

| 16 Oak Roble | 17 Walnut Nogal | M2 Matt black lacquered Negro mate lacado | Ø | H | ↓ | ☐ |
|--------------------|-----------------------|---|------|----|---|----|
| 0538029W16 | 0538029W17 | 0538029WM2 | 29,4 | 22 | 1 | 25 |
| 0538043W16 | 0538043W17 | 0538043WM2 | 43 | 25 | 1 | 25 |

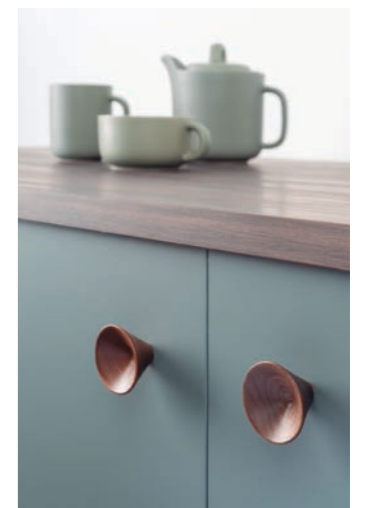

0538 **CONIC**

ZAMAK

Design: Kaschkasch

NEW!

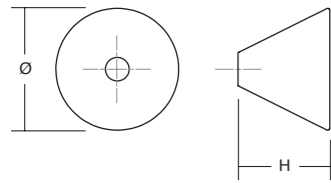

| M1 | M2 | M25 | Ø | H | ↓ | ☐ |
|----------------------------------|---------------------------------|--------------------------------|------|----|---|----|
| Matt white <i>Blanco mate</i> | Matt black <i>Negro mate</i> | Moss grey <i>Gris musgo</i> | | | | |
| 0538029ZM1 | 0538029ZM2 | 0538029ZM25 | 29,4 | 22 | 1 | 25 |
| 0538043ZM1 | 0538043ZM2 | 0538043ZM25 | 43 | 25 | 1 | 25 |

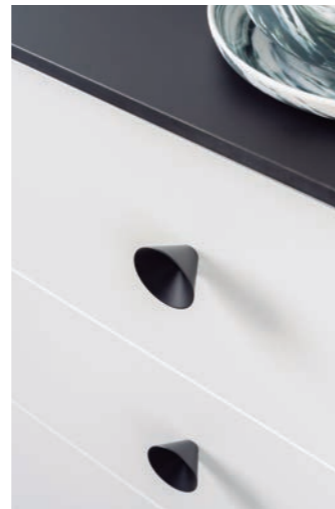

0543 **SOFT**

ZAMAK

Design: Uli Budde

NEW!

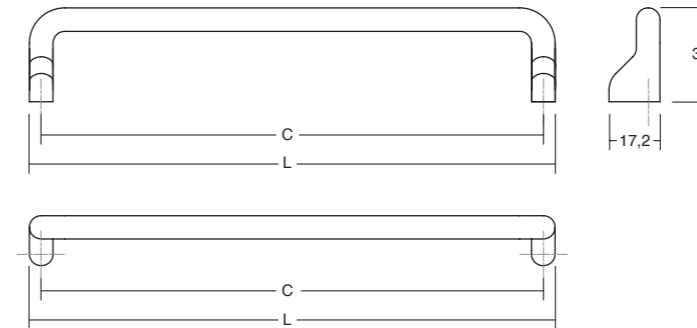

| M1 | M2 | M25 | C | L | ↓ | ☐ |
|----------------------------------|---------------------------------|--------------------------------|-----|-----|---|----|
| Matt white <i>Blanco mate</i> | Matt black <i>Negro mate</i> | Moss grey <i>Gris musgo</i> | | | | |
| 0543032ZM1 | 0543032ZM2 | 0543032ZM25 | 32 | 40 | 2 | 25 |
| 0543192ZM1 | 0543192ZM2 | 0543192ZM25 | 192 | 200 | 2 | 25 |
| 0543320ZM1 | 0543320ZM2 | 0543320ZM25 | 320 | 328 | 2 | 25 |

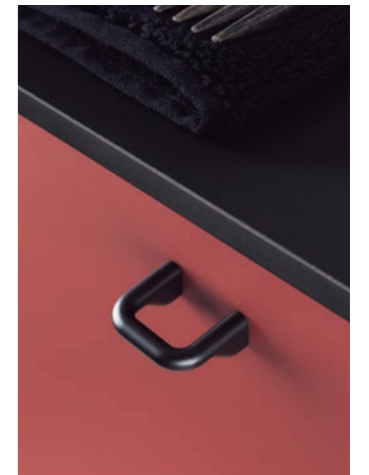
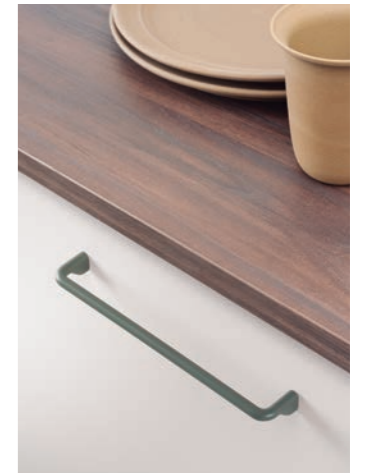

0542 **FOLD**

ZAMAK

Design: Teruel - Paré

NEW!

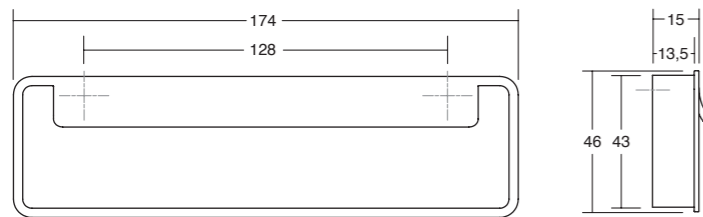

| 23 | 620 | M1 | M2 | ↓ | ☐ |
|---|-----------------------|----------------------------------|---------------------------------|---|----|
| Brushed nickel <i>Niquel cepillado</i> | Brass <i>Latón</i> | Matt white <i>Blanco mate</i> | Matt black <i>Negro mate</i> | | |
| 0542128Z23 | 0542128Z620 | 0542128ZM1 | 0542128ZM2 | 2 | 25 |



0552 **RIM**

ZAMAK

Design: Bernat Llorch

NEW!

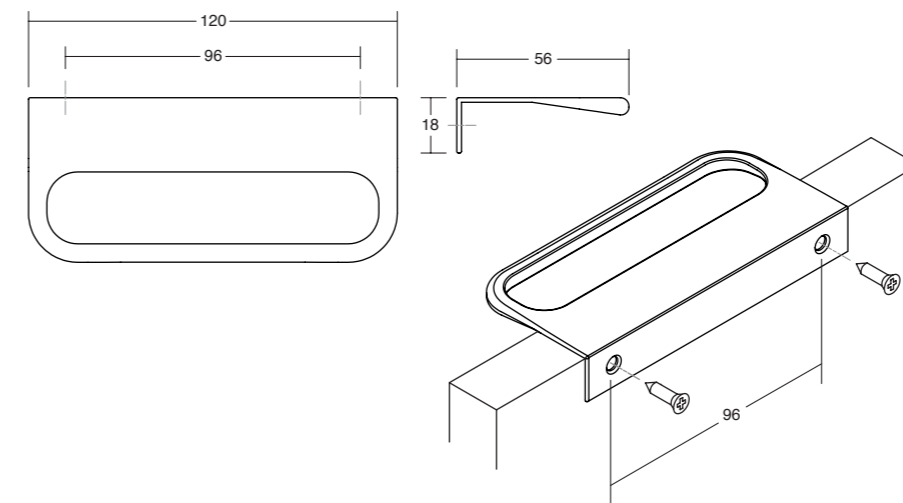

| 23 | 620 | M1 | M2 | M25 | ↓ | ☐ |
|---|-----------------------|----------------------------------|---------------------------------|--------------------------------|---|----|
| Brushed nickel <i>Niquel cepillado</i> | Brass <i>Latón</i> | Matt white <i>Blanco mate</i> | Matt black <i>Negro mate</i> | Moss grey <i>Gris musgo</i> | | |
| 0552096Z23 | 0552096Z620 | 0552096ZM1 | 0552096ZM2 | 0552096ZM25 | 2 | 25 |



0553 **OTO**

ZAMAK

Design: Bernat Llloch

NEW!

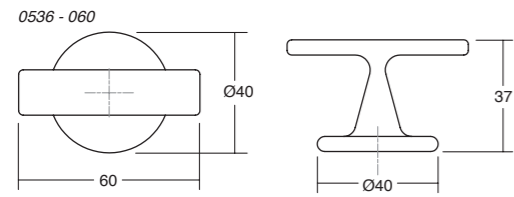
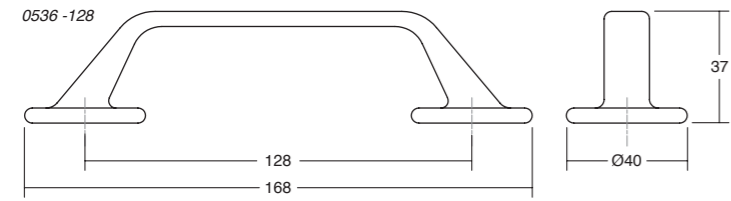

| | | | |
|-------------------|---|----|--|
| M22 | | | |
| Black textured | ↓ | ☐ | |
| Negro texturizado | | | |
| 0553060ZM22 | 1 | 25 | |
| 0553128ZM22 | 2 | 25 | |

0583 **ARPA**

ALUMINIUM

Design: Viefie®

NEW!



| 24 | 291 | 30 | C1 | C2 | L | ↓ | ☐ | |
|----------------------|------------------------|-----------------|------|-----|------|---|----|--|
| Stainless steel look | Brushed dark brass | Brushed black | | | | | | |
| Inox look | Latón oscuro cepillado | Negro cepillado | | | | | | |
| 0583070L24 | 0583070L291 | 0583070L30 | - | - | 70 | 1 | 25 | Includes non-twisting tip Incluye punta anti-giro |
| 0583192L24 | 0583192L291 | 0583192L30 | 192 | - | 214 | 2 | 25 | |
| 0583320L24 | 0583320L291 | 0583320L30 | 320 | - | 342 | 2 | 25 | |
| 05831178L24 | 05831178L291 | 05831178L30 | 1178 | 589 | 1200 | 3 | 15 | |

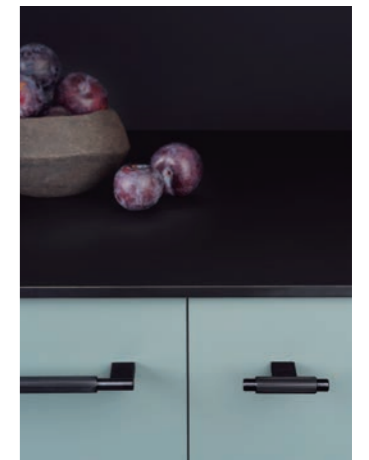
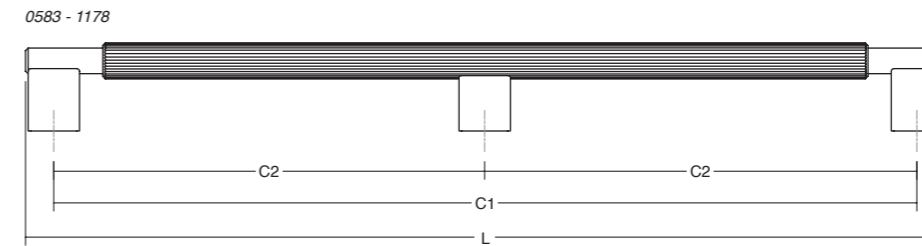
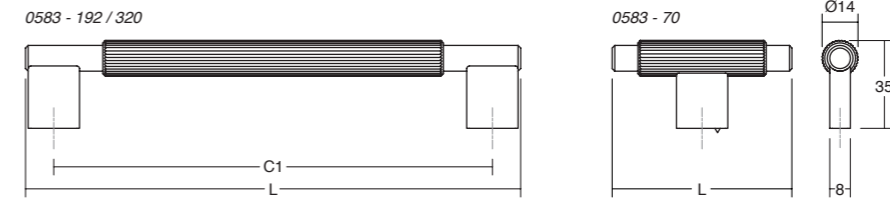

0556 **DIPO**

ZAMAK

Design: Bernat Llloch

NEW!

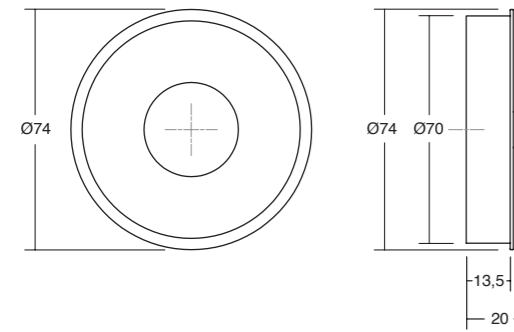

| | | | |
|-------------|------------|-------------|------|
| M1 | M2 | M25 | |
| Matt white | Matt black | Moss grey | ↓ ☐ |
| Blanco mate | Negro mate | Gris musgo | |
| 0556070ZM1 | 0556070ZM2 | 0556070ZM25 | 1 25 |

0588 **ARPA PLATE**

ALUMINIUM

Design: Viefie®

NEW!



| 24 | 291 | 30 | C1 | C2 | L | ↓ | ☐ | |
|----------------------|------------------------|-----------------|------|-----|------|---|----|--|
| Stainless steel look | Brushed dark brass | Brushed black | | | | | | |
| Inox look | Latón oscuro cepillado | Negro cepillado | | | | | | |
| 0588070L24 | 0588070L291 | 0588070L30 | - | - | 70 | 1 | 25 | |
| 0588192L24 | 0588192L291 | 0588192L30 | 192 | - | 230 | 2 | 25 | |
| 0588320L24 | 0588320L291 | 0588320L30 | 320 | - | 358 | 2 | 25 | |
| 05881178L24 | 05881178L291 | 05881178L30 | 1178 | 589 | 1216 | 3 | 15 | |

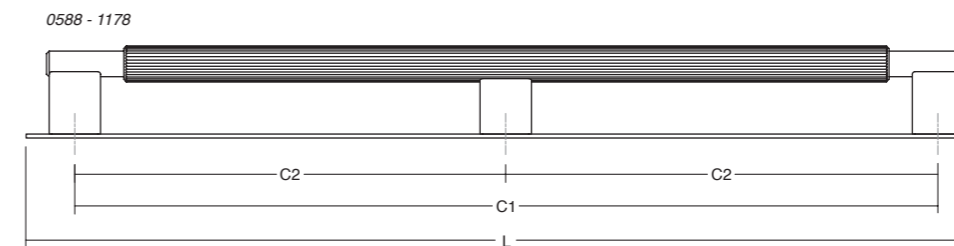
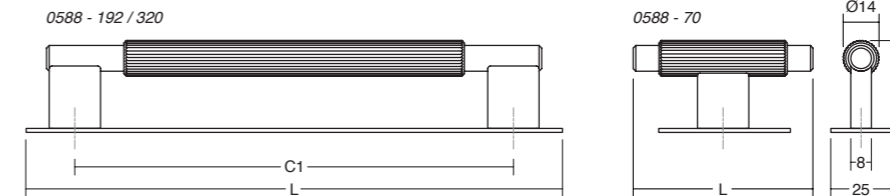

0495 **FLOID** ZAMAK Design: Frank Person

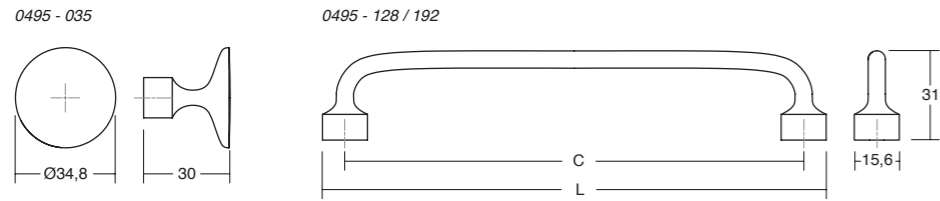

| 28 | 610 | 614 | M2 | C | L | ↓ | ☐ |
|-------------------------------|------------------|--------------------------------|--------------------------|-----|-------|---|----|
| Brushed gold Oro cepillado | Pewter Peltre | Antique brass Latón antiguo | Matt black Negro mate | | | | |
| 0495035Z28 | 0495035Z610 | 0495035Z614 | 0495035ZM2 | - | - | 1 | 25 |
| 0495128Z28 | 0495128Z610 | 0495128Z614 | 0495128ZM2 | 128 | 143,6 | 2 | 25 |
| 0495192Z28 | 0495192Z610 | 0495192Z614 | 0495192ZM2 | 192 | 207,6 | 2 | 25 |



0496 **BAU** ZAMAK Design: Patricia Roig

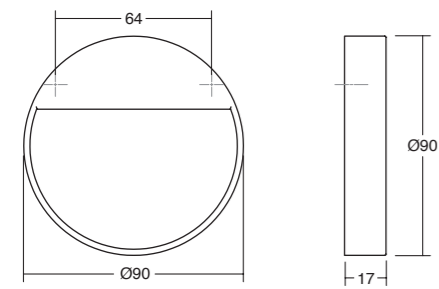

| 23 | 28 | M2 | ↓ | ☐ |
|------------------------------------|-------------------------------|--------------------------|---|----|
| Brushed nickel Níquel cepillado | Brushed gold Oro cepillado | Matt black Negro mate | | |
| 0496064Z23 | 0496064Z28 | 0496064ZM2 | 2 | 25 |

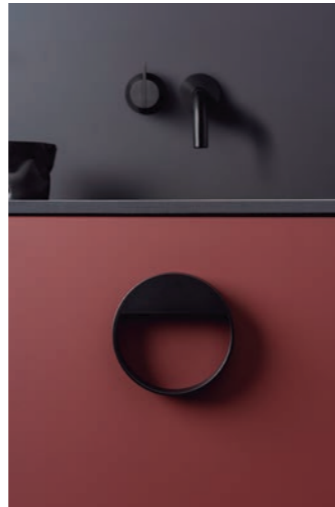

0487 **PURA** ZAMAK Design: Balutto Associati

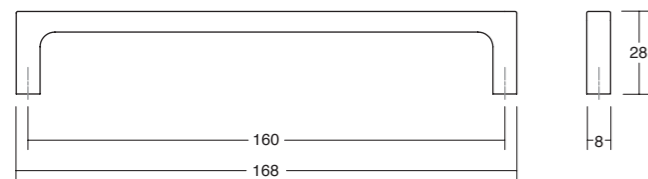

| 01 | 03 | 06 | 07 | ↓ | ☐ |
|---------------------------------|--|---------------------------------|--------------------------------|---|----|
| Polished chrome Cromo brillo | Polished black nickel Níquel negro brillo | Polished copper Cobre brillo | Polished brass Latón brillo | | |
| 0487160Z01 | 0487160Z03 | 0487160Z06 | 0487160Z07 | 2 | 25 |

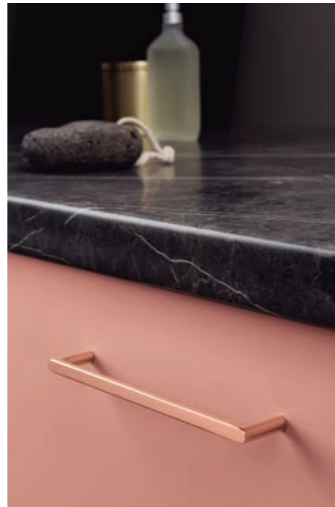

0127 **JEY** ALUMINIUM Design: Viefe®

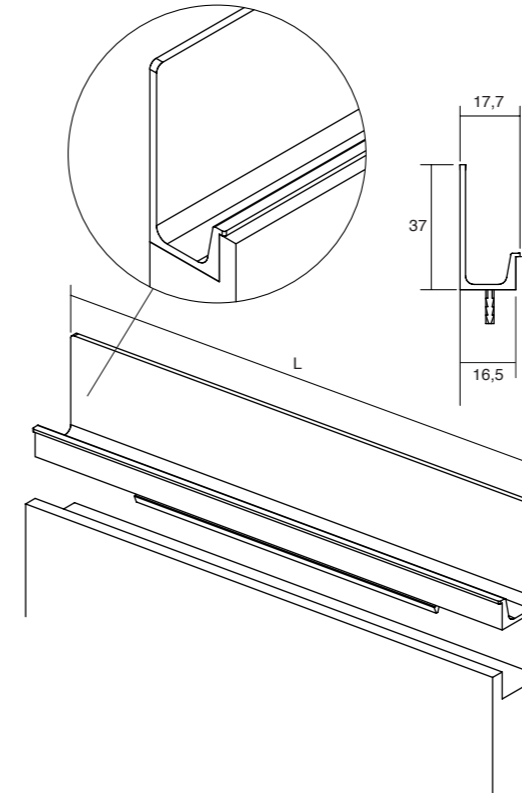

| 24 | 618 | M1 | M2 | L | ☐ |
|-----------------------------------|--|---------------------------|--------------------------|------|------|
| Stainless steel look Inox look | Brushed brass cava Latón cava cepillado | Matt white Blanco mate | Matt black Negro mate | | |
| 0127147L24 | 0127147L618 | 0127147LM1 | 0127147LM2 | 147 | 15 |
| 0127197L24 | 0127197L618 | 0127197LM1 | 0127197LM2 | 197 | 15 |
| 0127247L24 | 0127247L618 | 0127247LM1 | 0127247LM2 | 247 | 15 |
| 0127297L24 | 0127297L618 | 0127297LM1 | 0127297LM2 | 297 | 15 |
| 0127347L24 | 0127347L618 | 0127347LM1 | 0127347LM2 | 347 | 15 |
| 0127397L24 | 0127397L618 | 0127397LM1 | 0127397LM2 | 397 | 15 |
| 0127447L24 | 0127447L618 | 0127447LM1 | 0127447LM2 | 447 | 10 |
| 0127497L24 | 0127497L618 | 0127497LM1 | 0127497LM2 | 497 | 10 |
| 0127597L24 | 0127597L618 | 0127597LM1 | 0127597LM2 | 597 | 10 |
| 0127697L24 | 0127697L618 | 0127697LM1 | 0127697LM2 | 697 | 10 |
| 0127797L24 | 0127797L618 | 0127797LM1 | 0127797LM2 | 797 | 10 |
| 0127897L24 | 0127897L618 | 0127897LM1 | 0127897LM2 | 897 | 5 |
| 0127997L24 | 0127997L618 | 0127997LM1 | 0127997LM2 | 997 | 5 |
| 01271197L24 | 01271197L618 | 01271197LM1 | 01271197LM2 | 1197 | 5 |
| - | - | 01273000LM1 | 01273000LM2 | 3000 | 15 * |

* Available only in M1 and M2 finishes / Disponible solo en los acabados M1 y M2

0163 **JEY2** ALUMINIUM Design: Viefe®

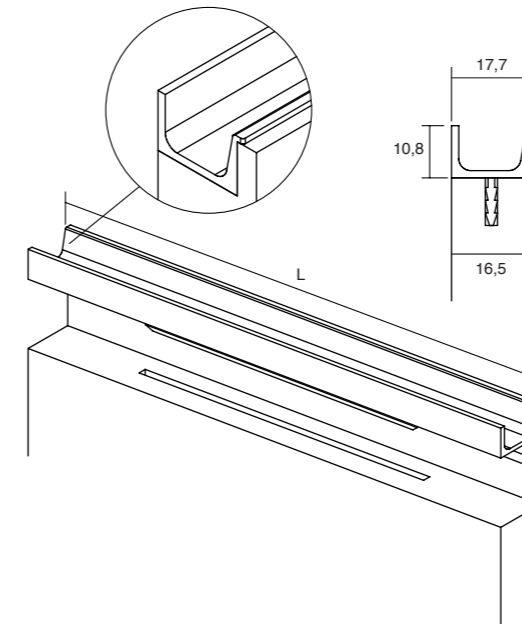

| 24 | 618 | M1 | M2 | L | ☐ |
|-----------------------------------|--|---------------------------|--------------------------|------|------|
| Stainless steel look Inox look | Brushed brass cava Latón cava cepillado | Matt white Blanco mate | Matt black Negro mate | | |
| 0163147L24 | 0163147L618 | 0163147LM1 | 0163147LM2 | 147 | 15 |
| 0163197L24 | 0163197L618 | 0163197LM1 | 0163197LM2 | 197 | 15 |
| 0163247L24 | 0163247L618 | 0163247LM1 | 0163247LM2 | 247 | 15 |
| 0163297L24 | 0163297L618 | 0163297LM1 | 0163297LM2 | 297 | 15 |
| 0163347L24 | 0163347L618 | 0163347LM1 | 0163347LM2 | 347 | 15 |
| 0163397L24 | 0163397L618 | 0163397LM1 | 0163397LM2 | 397 | 15 |
| 0163447L24 | 0163447L618 | 0163447LM1 | 0163447LM2 | 447 | 10 |
| 0163497L24 | 0163497L618 | 0163497LM1 | 0163497LM2 | 497 | 10 |
| 0163597L24 | 0163597L618 | 0163597LM1 | 0163597LM2 | 597 | 10 |
| 0163697L24 | 0163697L618 | 0163697LM1 | 0163697LM2 | 697 | 10 |
| 0163797L24 | 0163797L618 | 0163797LM1 | 0163797LM2 | 797 | 10 |
| 0163897L24 | 0163897L618 | 0163897LM1 | 0163897LM2 | 897 | 5 |
| 0163997L24 | 0163997L618 | 0163997LM1 | 0163997LM2 | 997 | 5 |
| 01631197L24 | 01631197L618 | 01631197LM1 | 01631197LM2 | 1197 | 5 |
| - | - | 01633000LM1 | 01633000LM2 | 3000 | 15 * |

* Available only in M1 and M2 finishes / Disponible solo en los acabados M1 y M2

0168 **COMO** ZAMAK Design: Viefef®

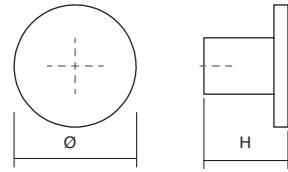

| 01 | 03 | 06 | 07 | 11 | 23 | 26 | 28 | M1 | M2 | Ø | H | ↓ | ☐ |
|---------------------|----------------------------|---------------------|---------------------|-------------------|-------------------------|------------------------|----------------------|--------------------|-------------------|----|----|---|----|
| Polished chrome | Polished black nickel | Polished copper | Polished brass | Matt chrome | Brushed nickel | Brushed copper | Brushed gold | Matt white | Matt black | | | | |
| <i>Cromo brillo</i> | <i>Níquel negro brillo</i> | <i>Cobre brillo</i> | <i>Latón brillo</i> | <i>Cromo mate</i> | <i>Níquel cepillado</i> | <i>Cobre cepillado</i> | <i>Oro cepillado</i> | <i>Blanco mate</i> | <i>Negro mate</i> | | | | |
| 0168026Z01 | 0168026Z03 | 0168026Z06 | 0168026Z07 | 0168026Z11 | 0168026Z23 | 0168026Z26 | 0168026Z28 | 0168026ZM1 | 0168026ZM2 | 26 | 18 | 1 | 25 |
| 0168041Z01 | 0168041Z03 | 0168041Z06 | 0168041Z07 | 0168041Z11 | 0168041Z23 | 0168041Z26 | 0168041Z28 | 0168041ZM1 | 0168041ZM2 | 41 | 25 | 1 | 25 |

0490 **SWITCH** ZAMAK Design: Viefef®

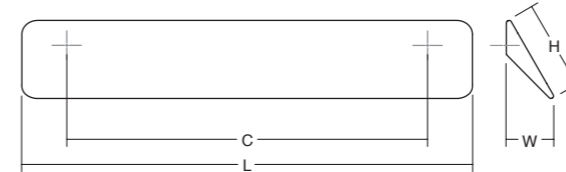

| 23 | M1 | M2 | C | L | H | W | ↓ | ☐ |
|-------------------------|--------------------|-------------------|-----|-----|----|------|---|----|
| Brushed nickel | Matt white | Matt black | | | | | | |
| <i>Níquel cepillado</i> | <i>Blanco mate</i> | <i>Negro mate</i> | | | | | | |
| 0490032Z23 | 0490032ZM1 | 0490032ZM2 | 32 | 50 | 50 | 26,4 | 2 | 25 |
| 0490160Z23 | 0490160ZM1 | 0490160ZM2 | 160 | 200 | 40 | 21,3 | 2 | 25 |

0497 **DIABOLO** ALUMINIUM Design: Frank Person

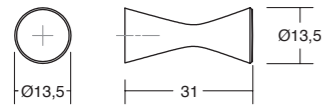

| 24 | 291 | 30 | 31 | ↓ | ☐ |
|----------------------|-------------------------------|------------------------|-----------------------|---|----|
| Stainless steel look | Brushed dark brass | Brushed black | Brushed grey | | |
| <i>Inox look</i> | <i>Latón oscuro cepillado</i> | <i>Negro cepillado</i> | <i>Gris cepillado</i> | | |
| 0497014L24 | 0497014L291 | 0497014L30 | 0497014L31 | 1 | 25 |

0518 **WAY** ALUMINIUM Design: Viefef®

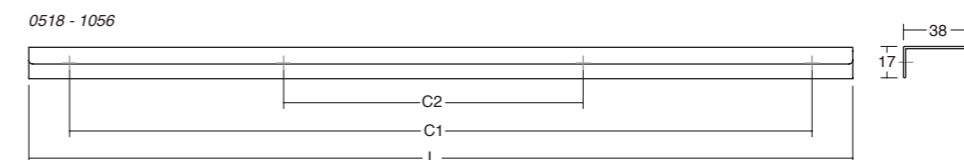
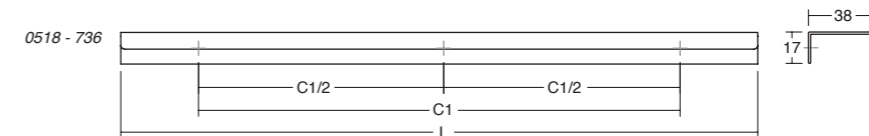
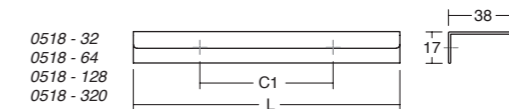

0499 **ROUND** ALUMINIUM Design: Balutto Associati

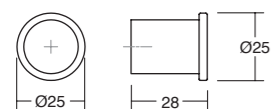

| 24 | 291 | 30 | ↓ | ☐ |
|----------------------|-------------------------------|------------------------|---|----|
| Stainless steel look | Brushed dark brass | Brushed black | | |
| <i>Inox look</i> | <i>Latón oscuro cepillado</i> | <i>Negro cepillado</i> | | |
| 0499025L24 | 0499025L291 | 0499025L30 | 1 | 25 |

| 04 | 09 | 24 | 29 | M1 | C1 | C1/2 | C2 | L | ↓ | ☐ |
|-----------------------|-------------------|----------------------|-------------------------------|--------------------|------|------|-----|------|---|----|
| Anodized matt | Matt black | Stainless steel look | Brushed dark brass | Matt White | | | | | | |
| <i>Anodizado mate</i> | <i>Negro mate</i> | <i>Inox look</i> | <i>Latón oscuro cepillado</i> | <i>Blanco mate</i> | | | | | | |
| 0518032L04 | 0518032L09 | 0518032L24 | 0518032L29 | 0518032LM1 | 32 | - | - | 50 | 2 | 25 |
| 0518064L04 | 0518064L09 | 0518064L24 | 0518064L29 | 0518064LM1 | 64 | - | - | 100 | 2 | 25 |
| 0518128L04 | 0518128L09 | 0518128L24 | 0518128L29 | 0518128LM1 | 128 | - | - | 200 | 2 | 25 |
| 0518320L04 | 0518320L09 | 0518320L24 | 0518320L29 | 0518320LM1 | 320 | - | - | 400 | 2 | 25 |
| 0518736L04 | 0518736L09 | 0518736L24 | 0518736L29 | 0518736LM1 | 736 | 368 | - | 800 | 3 | 25 |
| 05181056L04 | 05181056L09 | 05181056L24 | 05181056L29 | 05181056LM1 | 1056 | - | 352 | 1100 | 4 | 15 |

0511 **RAIL** ALUMINIUM Design: Teruel - Paré

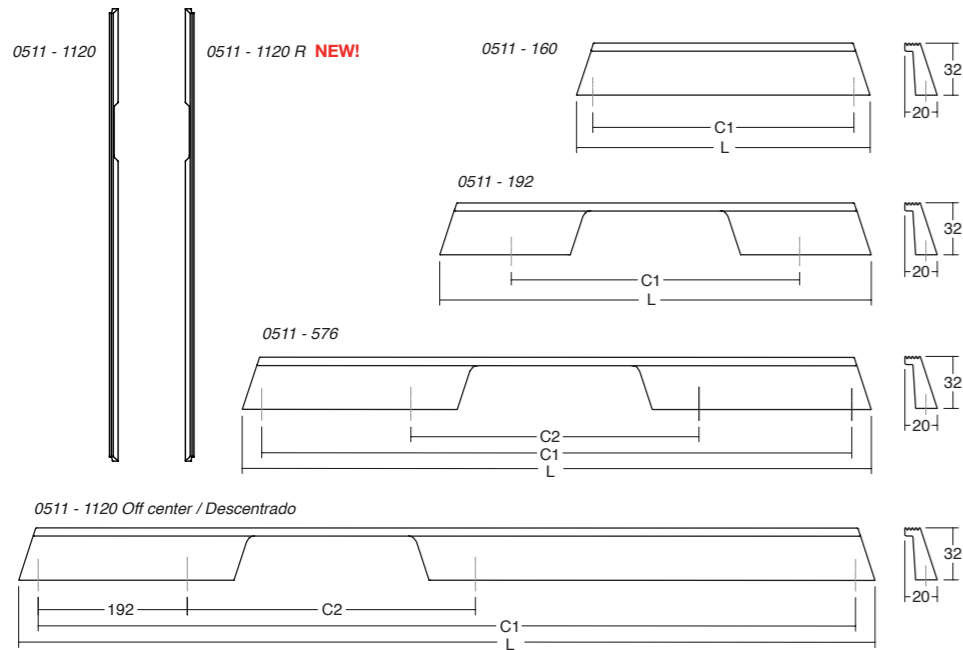

| 24 | 30 | 618 | C1 | C2 | L | ↓ | ☐ |
|-----------------------------------|----------------------------------|--|------|-----|------|---|----|
| Stainless steel look Inox look | Brushed black Negro cepillado | Brushed brass cava Latón cava cepillado | | | | | |
| 0511160L24 | 0511160L30 | 0511160L618 | 160 | - | 180 | 2 | 25 |
| 0511192L24 | 0511192L30 | 0511192L618 | 192 | - | 280 | 2 | 25 |
| 0511576L24 | 0511576L30 | 0511576L618 | 576 | 192 | 600 | 4 | 15 |
| 05111120L24* | 05111120L30* | 05111120L618* | 1120 | 192 | 1150 | 4 | 15 |
| NEW! 05111120L24R* | 05111120L30R* | 05111120L618R* | 1120 | 192 | 1150 | 4 | 15 |

* The two 1150mm are symmetrical and one is left and the other right / Los dos de 1150mm son simétricos y uno es izquierda y el otro derecha

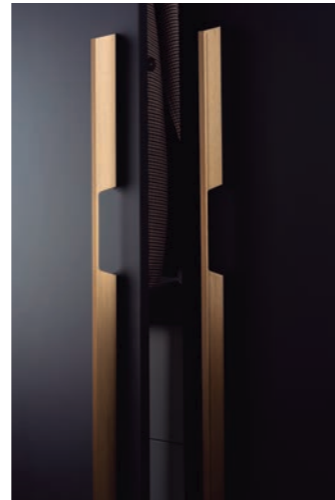

0241 **ROMA** ZAMAK Design: 2J Design

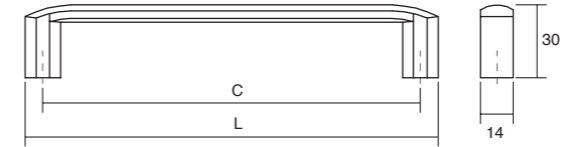

| 01 | 23 | 28 | M2 | C | L | ↓ | ☐ |
|---------------------------------|------------------------------------|-------------------------------|--------------------------|-----|-----|---|----|
| Polished chrome Cromo brillo | Brushed nickel Níquel cepillado | Brushed gold Oro cepillado | Matt black Negro mate | | | | |
| 0241160Z01 | 0241160Z23 | 0241160Z28 | 0241160ZM2 | 160 | 175 | 2 | 25 |
| 0241192Z01 | 0241192Z23 | 0241192Z28 | 0241192ZM2 | 192 | 207 | 2 | 25 |
| 0241320Z01 | 0241320Z23 | 0241320Z28 | 0241320ZM2 | 320 | 335 | 2 | 25 |



0503 **WALLACE** ZAMAK Design: Alexis Vivet

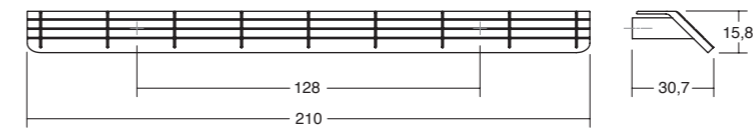

| 01 | 03 | 06 | 07 | ↓ | ☐ |
|---------------------------------|--|---------------------------------|--------------------------------|---|----|
| Polished chrome Cromo brillo | Polished black nickel Níquel negro brillo | Polished copper Cobre brillo | Polished brass Latón brillo | | |
| 0503128Z01 | 0503128Z03 | 0503128Z06 | 0503128Z07 | 2 | 25 |

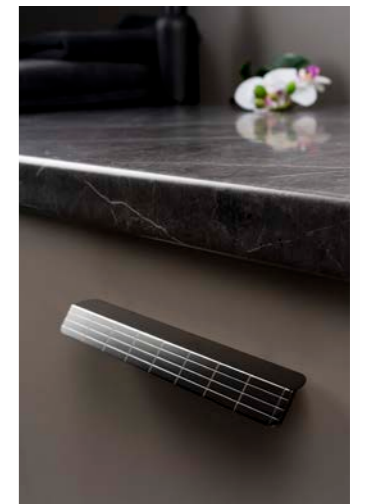

0056 **U** ZAMAK Design: Viefé®

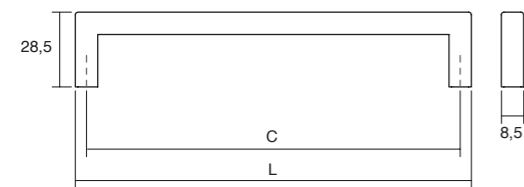

| 01 | 11 | 23 | 26 | 27 | 31 | M1 | M2 | C | L | ↓ | ☐ |
|---------------------------------|---------------------------|------------------------------------|-----------------------------------|----------------------------------|--------------------------------|---------------------------|--------------------------|-----|-------|---|----|
| Polished chrome Cromo brillo | Matt chrome Cromo mate | Brushed nickel Níquel cepillado | Brushed copper Cobre cepillado | Brushed brass Latón cepillado | Brushed grey Gris cepillado | Matt white Blanco mate | Matt black Negro mate | | | | |
| 0056128Z01 | 0056128Z11 | 0056128Z23 | 0056128Z26 | 0056128Z27 | 0056128Z31 | 0056128ZM1 | 0056128ZM2 | 128 | 136,5 | 2 | 25 |
| 0056160Z01 | 0056160Z11 | 0056160Z23 | 0056160Z26 | 0056160Z27 | 0056160Z31 | 0056160ZM1 | 0056160ZM2 | 160 | 168,5 | 2 | 25 |
| 0056192Z01 | 0056192Z11 | 0056192Z23 | 0056192Z26 | 0056192Z27 | 0056192Z31 | 0056192ZM1 | 0056192ZM2 | 192 | 200,5 | 2 | 25 |
| 0056320Z01 | 0056320Z11 | 0056320Z23 | 0056320Z26 | 0056320Z27 | 0056320Z31 | 0056320ZM1 | 0056320ZM2 | 320 | 328,5 | 2 | 25 |
| 0056492Z01 | 0056492Z11 | 0056492Z23 | 0056492Z26 | 0056492Z27 | 0056492Z31 | 0056492ZM1 | 0056492ZM2 | 492 | 500,5 | 2 | 25 |

0489 **BOL** ZAMAK / WOOD Design: Balutto Associati

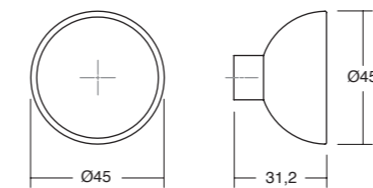

| M2+22 | M2+23 | M2+M1 | ↓ | ☐ |
|---|--|---|---|----|
| M2 Matt black + Sapelli Negro mate + Sapelli | M2 Matt black + Beech Negro mate + Haya | M2 Matt black + Matt white lacquered Negro mate + Lacado blanco mate | | |
| 0489045NM222 | 0489045NM223 | 0489045NM2M1 | 1 | 25 |



0507 **OBLONG** LEATHER / ZAMAK Design: Frank Person

0507 - 160

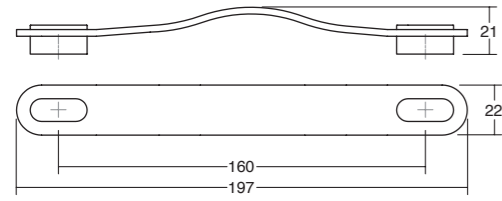

0507 - 070

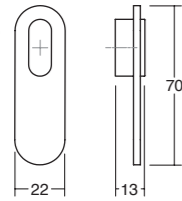

| | 26 Beige / Beige | 36 Brown / Marrón | 99 Black / Negro | ↓ | ☐ |
|----------------------------------|---------------------|----------------------|---------------------|---|----|
| 01 Polished chrome/ Cromo brillo | 0507070P2601 | 0507070P3601 | 0507070P9901 | 1 | 25 |
| 01 Polished chrome/ Cromo brillo | 0507160P2601 | 0507160P3601 | 0507160P9901 | 2 | 25 |
| 28 Brushed gold / Oro cepillado | 0507070P2628 | 0507070P3628 | 0507070P9928 | 1 | 25 |
| 28 Brushed gold / Oro cepillado | 0507160P2628 | 0507160P3628 | 0507160P9928 | 2 | 25 |
| 31 Brushed grey / Gris cepillado | 0507070P2631 | 0507070P3631 | 0507070P9931 | 1 | 25 |
| 31 Brushed grey / Gris cepillado | 0507160P2631 | 0507160P3631 | 0507160P9931 | 2 | 25 |
| M1 Matt white / Blanco mate | 0507070P26M1 | - | - | 1 | 25 |
| M1 Matt white / Blanco mate | 0507160P26M1 | - | - | 2 | 25 |
| M2 Matt black / Negro mate | 0507070P26M2 | 0507070P36M2 | 0507070P99M2 | 1 | 25 |
| M2 Matt black / Negro mate | 0507160P26M2 | 0507160P36M2 | 0507160P99M2 | 2 | 25 |

0494 **LAND** ZAMAK Design: Héctor Diego

0494 - 040

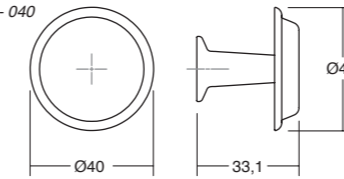

0494 - 064

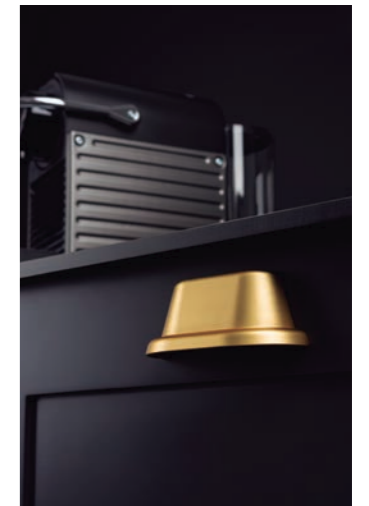
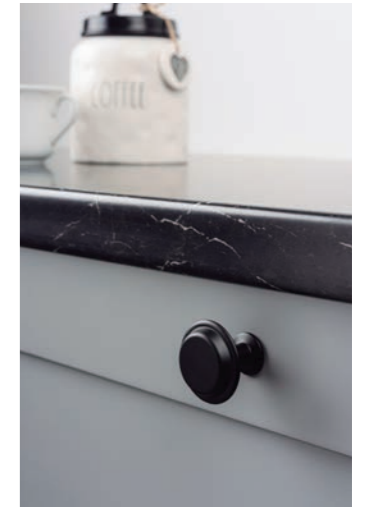
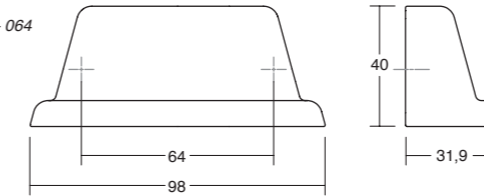

| 28 Brushed gold Oro cepillado | 610 Pewter Peltre | 614 Antique brass Latón antiguo | M2 Matt black Negro mate | ↓ | ☐ |
|-------------------------------------|-------------------------|---------------------------------------|--------------------------------|---|----|
| 0494040Z28 | 0494040Z610 | 0494040Z614 | 0494040ZM2 | 1 | 25 |
| 0494064Z28 | 0494064Z610 | 0494064Z614 | 0494064ZM2 | 2 | 25 |

0459 **LINES** ZAMAK Design: Teruel - Paré

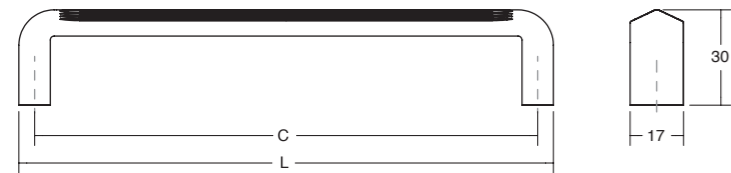

| 23 Brushed Níquel Níquel cepillado | 28 Brushed gold Oro cepillado | 32 Brushed mole grey Gris topo cepillado | M2 Matt black Negro mate | C | L | ↓ | ☐ |
|--|-------------------------------------|--|--------------------------------|-----|-----|---|----|
| 0459160Z23 | 0459160Z28 | 0459160Z32 | 0459160ZM2 | 160 | 170 | 2 | 25 |
| 0459320Z23 | 0459320Z28 | 0459320Z32 | 0459320ZM2 | 320 | 330 | 2 | 25 |

0467 **SKALA** ALUMINIUM Design: Alexis Vivet

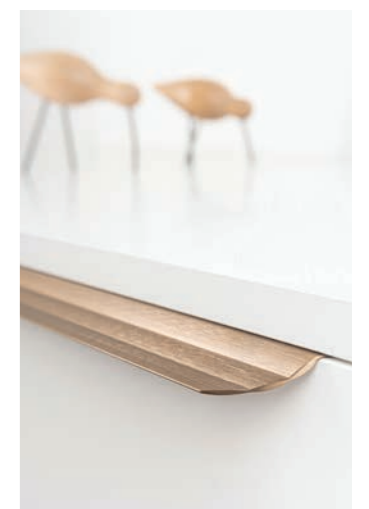
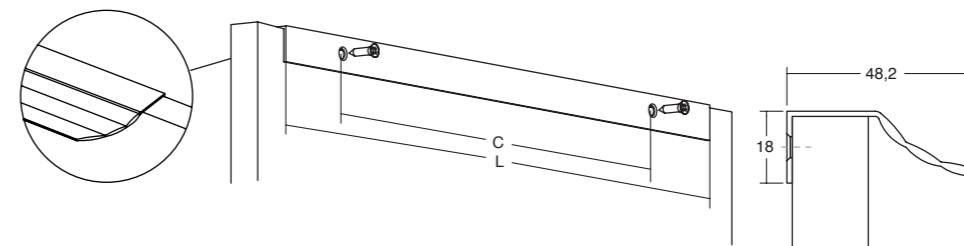

| 30 Brushed black Negro cepillado | 31 Brushed grey Gris cepillado | 613 Antique bronze Bronce antiguo | 618 Brushed brass cava Latón cava cepillado | C | L | ↓ | ☐ |
|--|--------------------------------------|---|---|-----|-----|---|----|
| 0467128L30 | 0467128L31 | 0467128L613 | 0467128L618 | 128 | 200 | 2 | 25 |
| 0467256L30 | 0467256L31 | 0467256L613 | 0467256L618 | 256 | 350 | 2 | 25 |

0506 **FIRM** ZAMAK Design: Frank Person

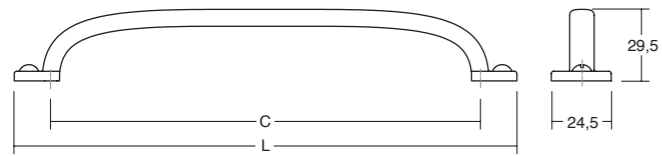

| M22 | C | L | ↓ | ☐ |
|--|-----|-------|---|----|
| Textured black <i>Negro texturizado</i> | | | | |
| 0506064ZM22 | 64 | 93,8 | 2 | 25 |
| 0506096ZM22 | 96 | 125,8 | 2 | 25 |
| 0506160ZM22 | 160 | 189,8 | 2 | 25 |
| 0506320ZM22 | 320 | 349,8 | 2 | 25 |

0516 **PENDANT** ZAMAK Design: Frank Person

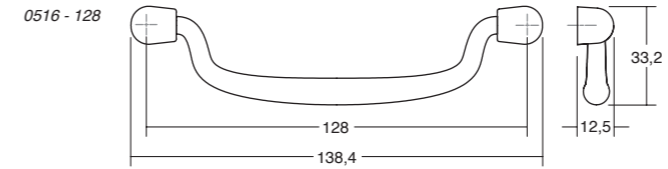
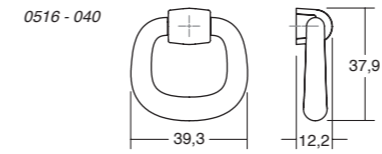
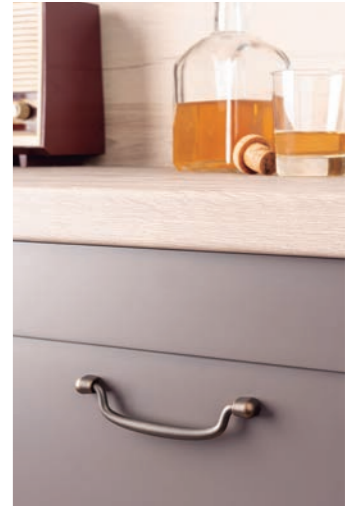
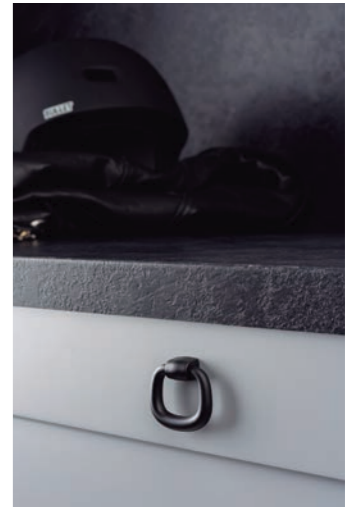

| 610 | 614 | M2 | ↓ | ☐ |
|-------------------------|---------------------------------------|---------------------------------|---|----|
| Pewter <i>Peltre</i> | Antique brass <i>Latón antiguo</i> | Matt black <i>Negro mate</i> | | |
| 0516040Z610 | 0516040Z614 | 0516040ZM2 | 1 | 25 |
| 0516128Z610 | 0516128Z614 | 0516128ZM2 | 2 | 25 |

0480 **NICE** ZAMAK Design: Héctor Diego

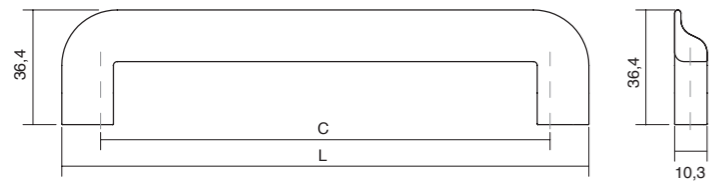

| 23 | 28 | 32 | M2 | C | L | ↓ | ☐ |
|---|--------------------------------------|---|---------------------------------|-----|-------|---|----|
| Brushed Nickel <i>Níquel cepillado</i> | Brushed gold <i>Oro cepillado</i> | Brushed mole grey <i>Gris topo cepillado</i> | Matt black <i>Negro mate</i> | | | | |
| 0480160Z23 | 0480160Z28 | 0480160Z32 | 0480160ZM2 | 160 | 184,6 | 2 | 25 |
| 0480320Z23 | 0480320Z28 | 0480320Z32 | 0480320ZM2 | 320 | 344,6 | 2 | 25 |

0446 **ESTE** ZAMAK Design: Balutto Associati

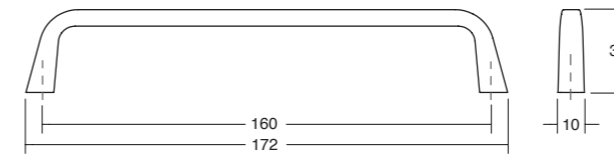
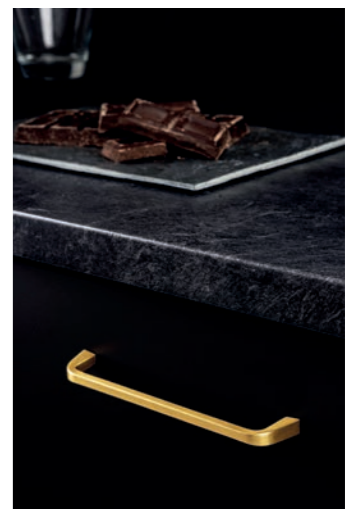

| 01 | 11 | 23 | 26 | 28 | 617 | M2 | ↓ | ☐ |
|--|----------------------------------|---|--|--------------------------------------|--------------------------------------|---------------------------------|---|----|
| Polished chrome <i>Cromo brillo</i> | Matt chrome <i>Cromo mate</i> | Brushed nickel <i>Níquel cepillado</i> | Brushed copper <i>Cobre cepillado</i> | Brushed gold <i>Oro cepillado</i> | Graphite grey <i>Gris grafito</i> | Matt black <i>Negro mate</i> | | |
| 0446160Z01 | 0446160Z11 | 0446160Z23 | 0446160Z26 | 0446160Z28 | 0446160Z617 | 0446160ZM2 | 2 | 25 |

0486 **GRAF BIG** ALUMINIUM Design: Viefte®

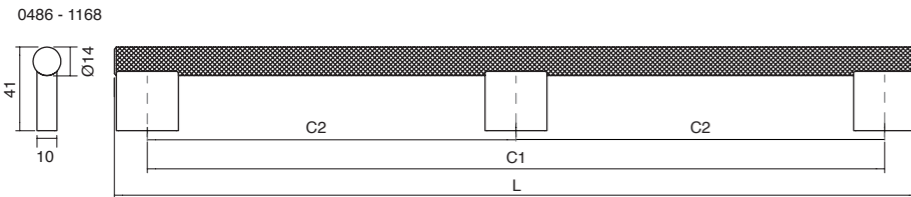
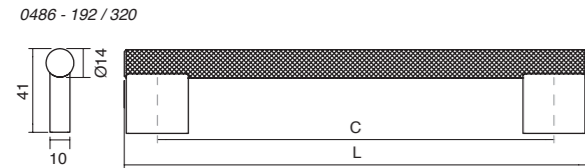
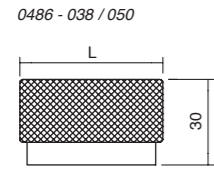

| 24 Stainless steel look Inox look | 291 Brushed dark brass Latón oscuro cepillado | 30 Brushed black Negro cepillado | C1 | C2 | L | ↓ | ☐ |
|---|---|--|------|-----|------|---|----|
| 0486038L24 | 0486038L291 | 0486038L30 | - | - | Ø38 | 1 | 25 |
| 0486050L24 | 0486050L291 | 0486050L30 | - | - | Ø50 | 1 | 25 |
| 0486192L24 | 0486192L291 | 0486192L30 | 192 | - | 224 | 2 | 25 |
| 0486320L24 | 0486320L291 | 0486320L30 | 320 | - | 352 | 2 | 25 |
| 04861168L24 | 04861168L291 | 04861168L30 | 1168 | 584 | 1200 | 3 | 10 |

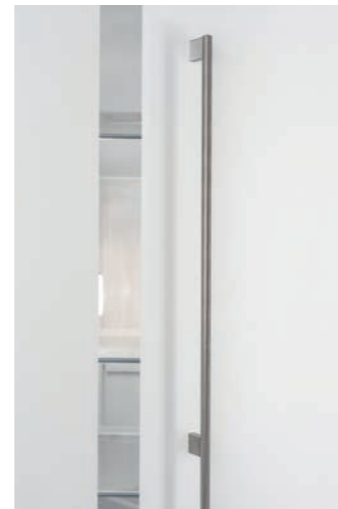

0430 **GRAF MINI** ALUMINIUM Design: Viefte®

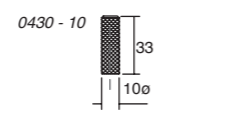
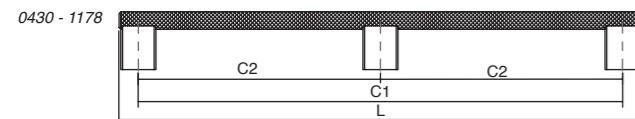
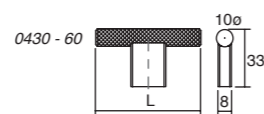
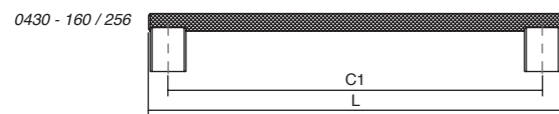

| 24 Stainless steel look Inox look | 291 Brushed dark brass Latón oscuro cepillado | 30 Brushed black Negro cepillado | C1 | C2 | L | ↓ | ☐ |
|---|---|--|------|-----|------|---|----|
| 0430010L24 | 0430010L291 | 0430010L30 | - | - | 10 | 1 | 25 |
| 0430060L24 | 0430060L291 | 0430060L30 | - | - | 60 | 1 | 25 |
| 0430160L24 | 0430160L291 | 0430160L30 | 160 | - | 182 | 2 | 25 |
| 0430256L24 | 0430256L291 | 0430256L30 | 256 | - | 278 | 2 | 25 |
| 04301178L24 | 04301178L291 | 04301178L30 | 1178 | 589 | 1200 | 3 | 10 |

Includes non-twisting tip / Incluye punta anti-giro

0109 **GRAF** ALUMINIUM Design: Viefte®

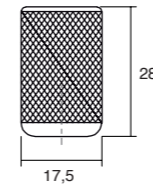

| 01 Polished chrome Cromo brillo | 04 Anodized matt Anodizado mate | 24 Stain. steel look Inox look | 27 Brushed brass Latón cepillado | 291 Brushed dark brass Latón oscuro cepillado | M2 Matt black Negro mate | ↓ | ☐ |
|---------------------------------------|---------------------------------------|--------------------------------------|--|---|--------------------------------|---|----|
| 0109017L01 | 0109017L04 | 0109017L24 | 0109017L27 | 0109017L291 | 0109017LM2 | 1 | 25 |



0447 **BELLA** ZAMAK Design: Balutto Associati

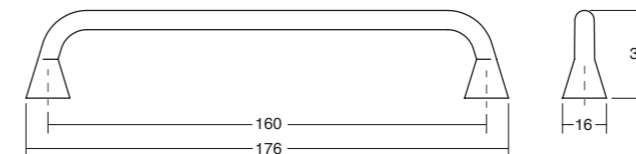

| 26 Brushed copper Cobre cepillado | 28 Brushed gold Oro cepillado | 617 Graphite grey Gris grafito | M2 Matt black Negro mate | ↓ | ☐ |
|---|-------------------------------------|--------------------------------------|--------------------------------|---|----|
| 0447160Z26 | 0447160Z28 | 0447160Z617 | 0447160ZM2 | 2 | 25 |



0451 **FELTRE** ZAMAK Design: Balutto Associati

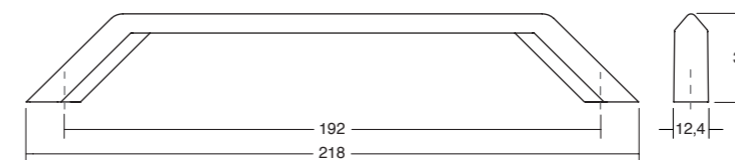

| 23 Brushed nickel Níquel cepillado | 617 Graphite grey Gris grafito | M2 Matt black Negro mate | ↓ | ☐ |
|--|--------------------------------------|--------------------------------|---|----|
| 0451192Z23 | 0451192Z617 | 0451192ZM2 | 2 | 25 |



0449 **HEXXA** ALUMINIUM/ZAMAK Design: Alexis Vivet

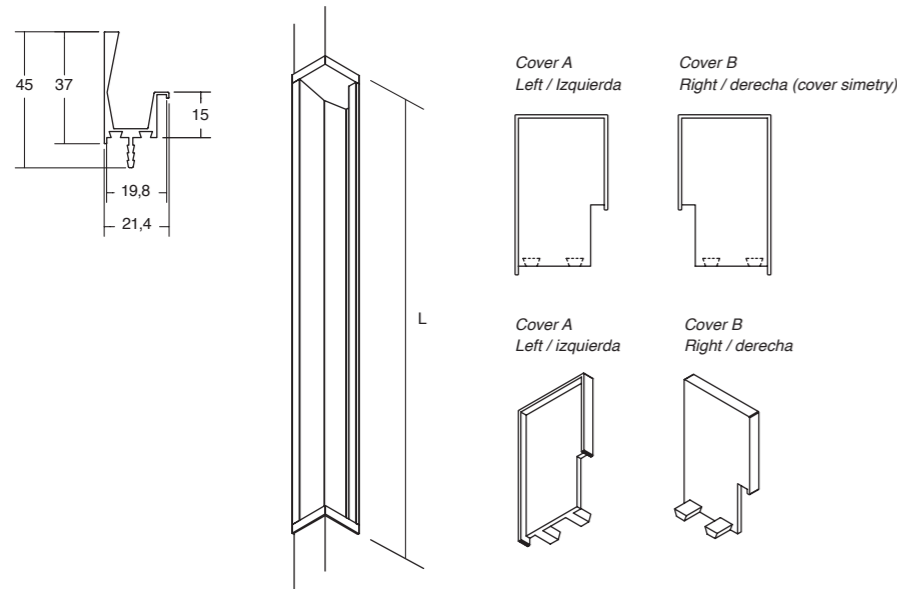

| M1 | M2 | M23 | M41 | L | ↓ | ☐ |
|---------------------------|--------------------------|-----------------------------|--------------------------------|------|----|-----------|
| Matt white Blanco mate | Matt black Negro mate | Metallic grey Gris metal | Metallic brown Marrón metal | | | |
| 0449200LM1 | 0449200LM2 | 0449200LM23 | 0449200LM41 | 200 | 25 | ALUMINIUM |
| 0449350LM1 | 0449350LM2 | 0449350LM23 | 0449350LM41 | 350 | 25 | ALUMINIUM |
| 04491100LM1 | 04491100LM2 | 04491100LM23 | 04491100LM41 | 1100 | 15 | ALUMINIUM |
| 04493000LM1 | 04493000LM2 | 04493000LM23 | 04493000LM41 | 3000 | 10 | ALUMINIUM |
| 0449035ZM1A | 0449035ZM2A | 0449035ZM23A | 0449035ZM41A | - | 25 | ZAMAK |
| 0449035ZM1B | 0449035ZM2B | 0449035ZM23B | 0449035ZM41B | - | 25 | ZAMAK |

0119 **WAVE** ZAMAK Design: Viefe®

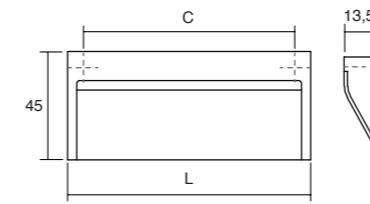

| 01 | 23 | M2 | C | L | ↓ | ☐ |
|---------------------------------|------------------------------------|--------------------------|-----|-----|---|----|
| Polished chrome Cromo brillo | Brushed nickel Níquel cepillado | Matt black Negro mate | | | | |
| 0119032Z01 | 0119032Z23 | 0119032ZM2 | 32 | 45 | 2 | 25 |
| 0119160Z01 | 0119160Z23 | 0119160ZM2 | 160 | 173 | 2 | 25 |

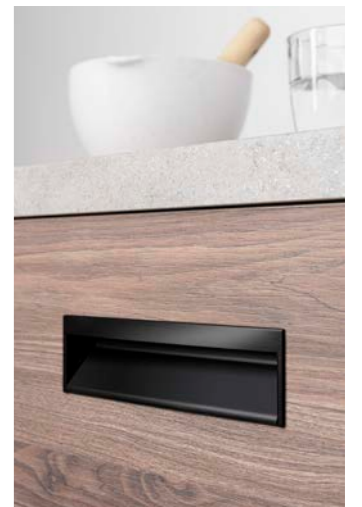

0105 **NEST** ZAMAK Design: Viefe®

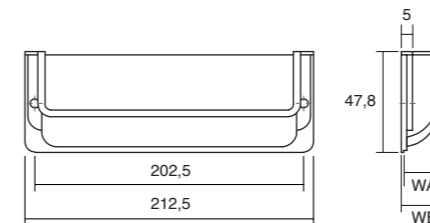

| 01 | 01 + M1 | 23 | 23 + M1 | M2 | WA | WB | ↓ | ☐ | Door |
|---------------------------------|---|------------------------------------|---|--------------------------|------|------|---|----|--------|
| Polished chrome Cromo brillo | Polished chrome+White Cromo brillo+ Blanco | Brushed nickel Níquel cepillado | Brushed nickel+White Níquel cepillado+Blanco | Matt black Negro mate | | | | | Puerta |
| 0105186Z01ST | 0105186Z01M1 | 0105186Z23ST | 0105186Z23M1 | 0105186ZM2ST | 18,6 | 21,3 | 2 | 25 | 19 |
| - | - | 0105206Z23ST | - | - | 20,6 | 23,3 | 2 | 25 | 20,5 |



0094 **HIDE** ZAMAK Design: Viefe®

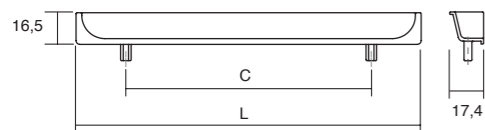

| 01 | 23 | 28 | P1 | M1 | M2 | C | L | ↓ | ☐ |
|---------------------------------|------------------------------------|-------------------------------|---------------------------|---------------------------|--------------------------|-----|-----|---|----|
| Polished chrome Cromo brillo | Brushed nickel Níquel cepillado | Brushed gold Oro cepillado | Chrome look Cromo look | Matt white Blanco mate | Matt black Negro mate | | | | |
| 0094090Z01 | 0094090Z23 | 0094090Z28 | - | 0094090ZM1 | 0094090ZM2 | 64 | 90 | 2 | 25 |
| 0094180Z01 | 0094180Z23 | 0094180Z28 | - | 0094180ZM1 | 0094180ZM2 | 128 | 180 | 2 | 25 |
| - | - | - | 0094200ZP1 | - | - | 128 | 200 | 2 | 25 |

0235 **CLOS** ZAMAK Design: Viefe®

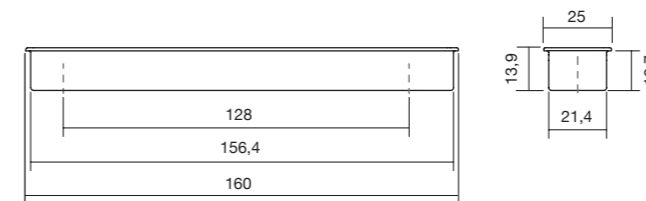

| M1 | M2 | Z01 | Z23 | ↓ | ☐ |
|---------------------------|--------------------------|---------------------------------|------------------------------------|---|----|
| Matt white Blanco mate | Matt black Negro mate | Polished chrome Cromo brillo | Brushed nickel Níquel cepillado | | |
| 0235128ZM1 | 0235128ZM2 | 0235128Z01 | 0235128Z23 | 2 | 25 |



0366 **CUBIC** ZAMAK Design: Viefte®

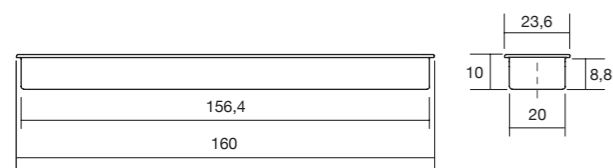

| | | |
|-------------|------------|----|
| M1 | M2 | |
| Matt white | Matt black | |
| Blanco mate | Negro mate | |
| 0366160ZM1 | 0366160ZM2 | 25 |



0195 **SENSE** ALUMINIUM Design: Viefte®

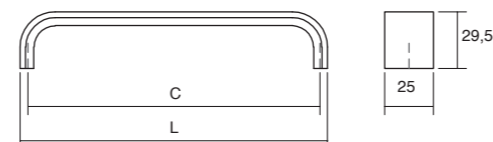

| | | | | | | |
|-----------------|----------------------|-----------------|----------|----------|----------|----------|
| 01 | 24 | 30 | C | L | ↓ | 📦 |
| Polished chrome | Stainless steel look | Brushed black | | | | |
| Cromo brillo | Inox look | Negro cepillado | | | | |
| 0195128L01 | 0195128L24 | 0195128L30 | 128 | 135 | 2 | 25 |
| 0195192L01 | 0195192L24 | 0195192L30 | 192 | 199 | 2 | 25 |
| 0195320L01 | 0195320L24 | 0195320L30 | 320 | 327 | 2 | 25 |
| 0195480L01 | 0195480L24 | 0195480L30 | 480 | 487 | 2 | 25 |



0073 **TAP** ZAMAK Design: Viefte®

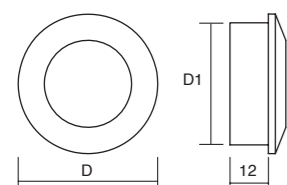

| | | | | |
|-------------|------------|----------|-----------|----------|
| P1 | M2 | D | D1 | 📦 |
| Chrome look | Matt black | | | |
| Cromo look | Negro mate | | | |
| 0073040ZP1 | 0073040ZM2 | 40 | 35,5 | 25 |
| 0073060ZP1 | 0073060ZM2 | 60 | 55,3 | 25 |



0162 **KADO** ZAMAK Design: Viefte®

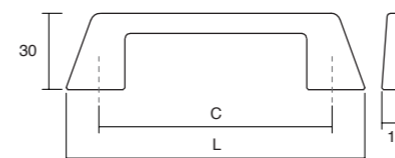

| | | | | | |
|-----------------|------------------|----------|----------|----------|----------|
| 01 | 23 | C | L | ↓ | 📦 |
| Polished chrome | Brushed nickel | | | | |
| Cromo brillo | Níquel cepillado | | | | |
| 0162160Z01 | 0162160Z23 | 160 | 186 | 2 | 25 |
| 0162320Z01 | 0162320Z23 | 320 | 346 | 2 | 25 |



0301 **SENSE MINI** ALUMINIUM Design: Viefte®

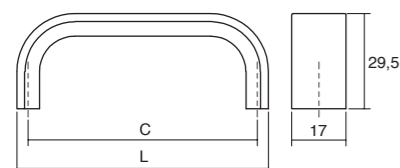

| | | | | | | | |
|-----------------|------------|----------------------|------------------------|----------|----------|----------|----------|
| 01 | 09 | 24 | 29 | C | L | ↓ | 📦 |
| Polished chrome | Matt black | Stainless steel look | Brushed dark brass | | | | |
| Cobre brillo | Negro mate | inox look | Latón oscuro cepillado | | | | |
| 0301096L01 | 0301096L09 | 0301096L24 | 0301096L29 | 96 | 103 | 2 | 25 |
| 0301160L01 | 0301160L09 | 0301160L24 | 0301160L29 | 160 | 167 | 2 | 25 |
| 0301256L01 | 0301256L09 | 0301256L24 | 0301256L29 | 256 | 263 | 2 | 25 |



0373 **NICK** ZAMAK Design: Alexis Vivet

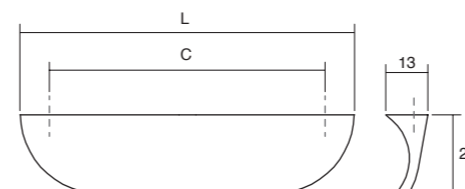

| | | | | | | | |
|-----------------|------------------|-----------------|-----------------|----------|----------|----------|----------|
| 01 | 23 | 26 | 27 | C | L | ↓ | 📦 |
| Polished chrome | Brushed nickel | Brushed copper | Brushed brass | | | | |
| Cromo brillo | Níquel cepillado | Cobre cepillado | Latón cepillado | | | | |
| 0373032Z01 | 0373032Z23 | 0373032Z26 | 0373032Z27 | 32 | 50 | 2 | 25 |
| 0373160Z01 | 0373160Z23 | 0373160Z26 | 0373160Z27 | 160 | 178 | 2 | 25 |



0077 **ANGLE** ALUMINIUM Design: Viefe®

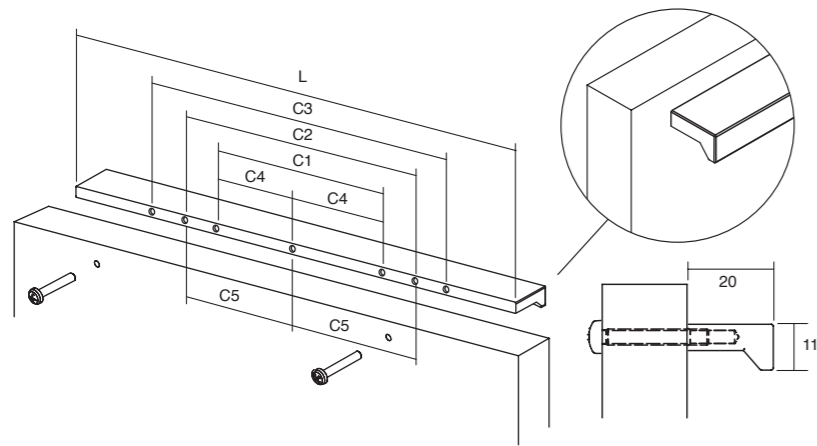

| 01 | 04 | 24 | 29 NEW! | M1 | M2 | M23 | M41 | C1 | C2 | C3 | C4 | C5 | L | ↓ | ☐ |
|----------------|----------------|------------------|--------------------|-------------|-------------|---------------|----------------|-----|------|-----|-----|-----|------|---|----|
| PolisH. chrome | Anodized matt | Stai. steel look | Brus. dark brass | Matt White | Matt black | Metallic grey | Metallic brown | | | | | | | | |
| Cromo brillo | Anodizado mate | Inox look | Ltn osc. cepillado | Blanco mate | Negro mate | Gris metal | Marrón metal | | | | | | | | |
| - | 0077032L04 | - | - | - | - | - | - | 32 | - | - | - | - | 45 | 2 | 25 |
| - | 0077064L04 | - | - | - | - | - | - | 64 | - | - | - | - | 90 | 2 | 25 |
| 0077064L01 | - | 0077064L24 | 0077064L29 | 0077064LM1 | 0077064LM2 | 0077064LM23 | 0077064LM41 | 64 | - | - | - | - | 100 | 2 | 25 |
| - | - | - | - | 0077128LM1 | 0077128LM2 | 0077128LM23 | 0077128LM41 | 128 | 160 | - | - | - | 200 | 4 | 25 |
| - | 0077096L04 | - | - | - | - | - | - | 96 | - | - | - | - | 120 | 2 | 25 |
| - | 0077128L04 | - | - | - | - | - | - | 128 | - | - | - | - | 150 | 2 | 25 |
| 0077128L01 | - | 0077128L24 | 0077128L29 | - | - | - | - | 96 | 128 | 160 | - | - | 200 | 6 | 25 |
| - | 0077160L04 | - | - | - | - | - | - | 160 | - | - | - | - | 190 | 2 | 25 |
| - | 0077192L04 | - | - | - | - | - | - | 192 | - | - | - | - | 250 | 2 | 25 |
| 0077192L01 | - | 0077192L24 | 0077192L29 | 0077192LM1 | 0077192LM2 | 0077192LM23 | 0077192LM41 | 192 | - | - | - | - | 300 | 2 | 25 |
| - | - | - | - | 0077256LM1 | 0077256LM2 | 0077256LM23 | 0077256LM41 | 256 | - | - | - | - | 400 | 2 | 25 |
| - | 0077256L04 | - | - | - | - | - | - | 256 | - | - | - | - | 300 | 2 | 25 |
| 0077256L01 | - | 0077256L24 | 0077256L29 | - | - | - | - | 256 | 320 | - | - | - | 400 | 4 | 25 |
| - | - | - | - | 0077416LM1 | 0077416LM2 | 0077416LM23 | 0077416LM41 | 416 | - | - | - | - | 500 | 2 | 25 |
| 0077416L01 | - | 0077416L24 | 0077416L29 | - | - | - | - | 320 | 416 | - | - | - | 500 | 4 | 25 |
| - | - | - | - | 0077480LM1 | 0077480LM2 | 0077480LM23 | 0077480LM41 | 480 | - | - | - | - | 600 | 2 | 25 |
| 0077512L01 | - | 0077512L24 | 0077512L29 | - | - | - | - | 480 | 512 | - | - | 256 | 600 | 5 | 25 |
| 0077640L01 | - | 0077640L24 | 0077640L29 | 0077640LM1 | 0077640LM2 | 0077640LM23 | 0077640LM41 | 640 | - | - | 320 | - | 900 | 3 | 25 |
| - | - | - | - | 00771440LM1 | 00771440LM2 | 00771440LM23 | 00771440LM41 | 480 | 1440 | - | - | - | 1480 | 4 | 10 |

0452 **BRAVE** ALUMINIUM Design: Viefe®

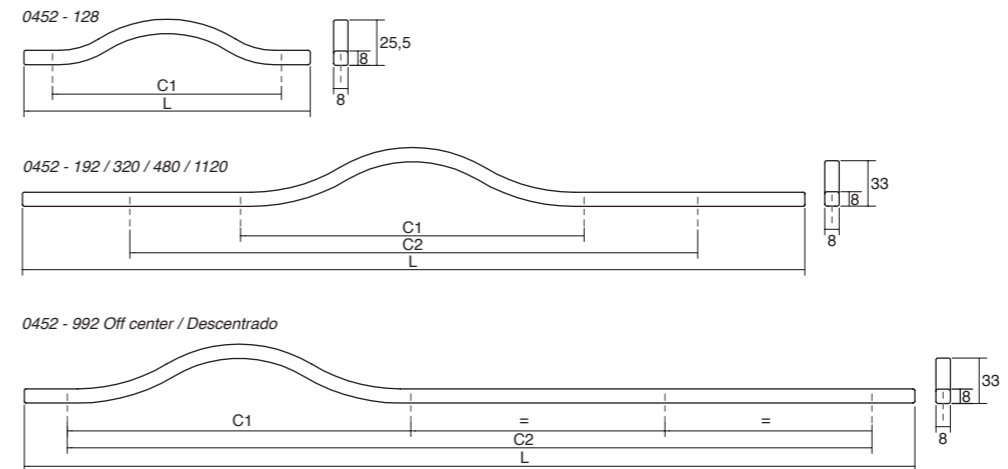

| M1 | M2 | M23 | M41 | C1 | C2 | L | ↓ | ☐ |
|-------------|-------------|---------------|----------------|-----|------|------|---|-----------------------------|
| Matt white | Matt black | Metallic grey | Metallic brown | | | | | |
| Blanco mate | Negro mate | Gris metal | Marrón metal | | | | | |
| 0452128FM1 | 0452128FM2 | 0452128FM23 | 0452128FM41 | 128 | - | 160 | 2 | 25 |
| 0452192FM1 | 0452192FM2 | 0452192FM23 | 0452192FM41 | 192 | - | 240 | 2 | 25 |
| 0452320FM1 | 0452320FM2 | 0452320FM23 | 0452320FM41 | 320 | - | 400 | 2 | 25 |
| 0452480FM1 | 0452480FM2 | 0452480FM23 | 0452480FM41 | 192 | 480 | 600 | 4 | 25 |
| 0452992FM1 | 0452992FM2 | 0452992FM23 | 0452992FM41 | 192 | 992 | 1040 | 4 | 15 Off-center / Descentrado |
| 04521120FM1 | 04521120FM2 | 04521120FM23 | 04521120FM41 | 192 | 1120 | 1150 | 4 | 15 |

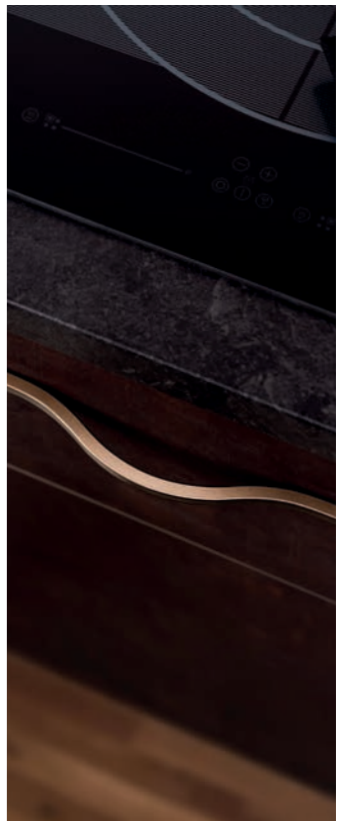

0341 **ASI** ALUMINIUM Design: Oriol Barri

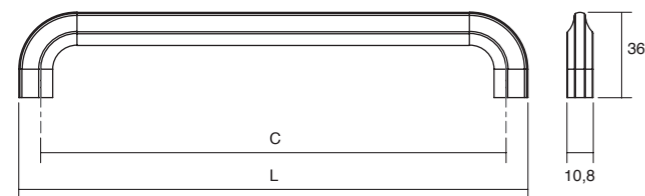

| M2 | C | L | ↓ | ☐ |
|------------|-----|-----|---|----|
| Matt black | | | | |
| Negro mate | | | | |
| 0341128LM2 | 128 | 146 | 2 | 25 |
| 0341192LM2 | 192 | 210 | 2 | 25 |
| 0341320LM2 | 320 | 338 | 2 | 25 |



0311 **TAMM** ALUMINIUM Design: Alexis Vivet

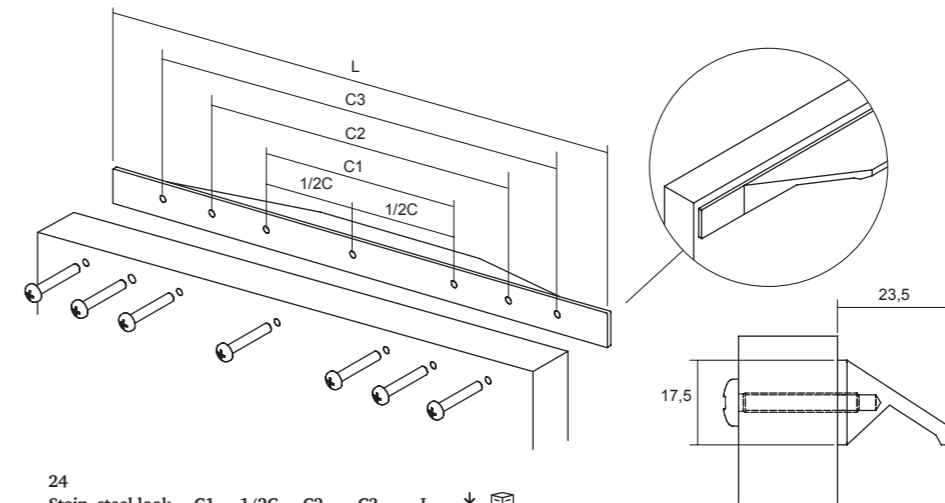

| 24 | C1 | 1/2C | C2 | C3 | L | ↓ | ☐ |
|-------------------|-----|------|------|------|------|---|----|
| Stain. steel look | | | | | | | |
| Inox look | | | | | | | |
| 0311140L24 | 32 | - | - | - | 140 | 2 | 15 |
| 0311190L24 | 64 | - | - | - | 190 | 2 | 15 |
| 0311240L24 | 128 | - | - | - | 240 | 2 | 15 |
| 0311290L24 | 160 | - | 174 | - | 290 | 4 | 15 |
| 0311340L24 | 192 | - | 224 | - | 340 | 4 | 15 |
| 0311390L24 | 256 | 128 | 274 | - | 390 | 5 | 15 |
| 0311440L24 | 256 | 128 | 324 | - | 440 | 5 | 10 |
| 0311490L24 | 320 | 160 | 374 | - | 490 | 5 | 10 |
| 0311590L24 | 448 | 224 | 474 | - | 590 | 5 | 10 |
| 0311690L24 | 512 | 256 | 574 | - | 690 | 5 | 10 |
| 0311790L24 | 224 | - | 608 | 674 | 790 | 6 | 10 |
| 0311890L24 | 320 | - | 704 | 774 | 890 | 6 | 5 |
| 0311990L24 | 320 | - | 832 | 874 | 990 | 6 | 5 |
| 03111190L24 | 384 | - | 1024 | 1074 | 1190 | 6 | 5 |



0444 **PEAK** ALUMINIUM Design: Viefie®

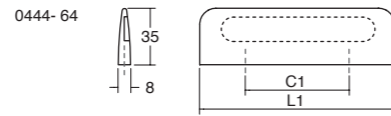

0444 - 1760 / 768 / 448 / 192

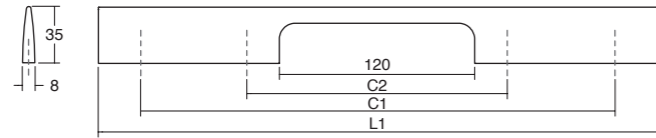

0444- 1120 Off center / Descentrado

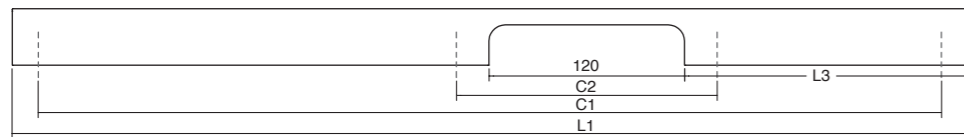

| 24 | 30 | M1 | M23 | M41 | C1 | C2 | L1 | L3 | ↓ | ☐ |
|--------------------------------|----------------------------------|---------------------------|-----------------------------|--------------------------------|------|-----|------|-----|---|----|
| Stain. steel look Inox look | Brushed black Negro cepillado | Matt white Blanco mate | Metallic grey Gris metal | Metallic brown Marrón metal | | | | | | |
| 0444064L24 | 0444064L30 | 0444064LM1 | 0444064LM23 | 0444064LM41 | 64 | - | 120 | - | 2 | 25 |
| 0444192L24 | 0444192L30 | 0444192LM1 | 0444192LM23 | 0444192LM41 | 192 | 160 | 250 | - | 4 | 25 |
| 0444448L24 | 0444448L30 | 0444448LM1 | 0444448LM23 | 0444448LM41 | 448 | 160 | 500 | - | 4 | 25 |
| 0444768L24 | 0444768L30 | 0444768LM1 | 0444768LM23 | 0444768LM41 | 768 | 160 | 800 | - | 4 | 15 |
| 04441120L24 | 04441120L30 | 04441120LM1 | 04441120LM23 | 04441120LM41 | 1120 | 160 | 1150 | 190 | 4 | 15 |
| 04441760L24 | 04441760L30 | 04441760LM1 | 04441760LM23 | 04441760LM41 | 1760 | 160 | 1800 | - | 4 | 10 |

0206 **ARCH** ZAMAK Design: 2J Design

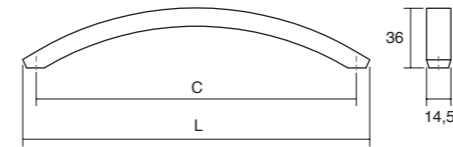

| 01 | 23 | C | L | ↓ | ☐ |
|---------------------------------|------------------------------------|-----|-------|---|----|
| Polished chrome Cromo brillo | Brushed nickel Níquel cepillado | | | | |
| 0206192Z01 | 0206192Z23 | 192 | 208,5 | 2 | 25 |
| 0206320Z01 | 0206320Z23 | 320 | 338,5 | 2 | 25 |

0372 **ONA** ALUMINIUM Design: Teruel Paré

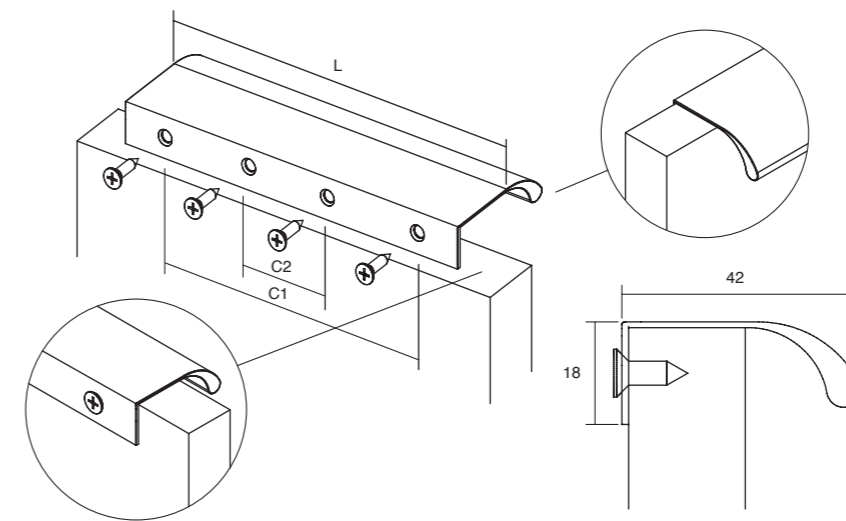

0053 **DINO** ZAMAK Design: Viefie®

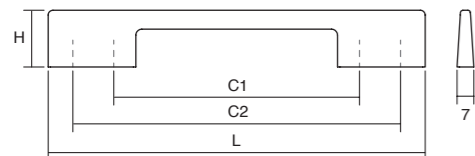

| 01 | 23 | M1 | M2 | P4 | C1 | C2 | L | H | ↓ | ☐ |
|---------------------------------|------------------------------------|---------------------------|--------------------------|---------------------------------|-----|-----|-----|----|---|----|
| Polished chrome Cromo brillo | Brushed nickel Níquel cepillado | Matt white Blanco mate | Matt black Negro mate | Aluminium look Aluminio look | | | | | | |
| 0053096Z01 | 0053096Z23 | 0053096ZM1 | 0053096ZM2 | 0053096ZP4 | 96 | 128 | 156 | 24 | 4 | 25 |
| 0053192Z01 | 0053192Z23 | 0053192ZM1 | 0053192ZM2 | 0053192ZP4 | 160 | 192 | 221 | 28 | 4 | 25 |
| 0053320Z01 | 0053320Z23 | 0053320ZM1 | 0053320ZM2 | 0053320ZP4 | 288 | 320 | 349 | 28 | 4 | 25 |

| 24 | 29 NEW! | 30 | 31 | M1 | M23 | M41 | C1 | C2 | L | ↓ | ☐ |
|-----------------------------------|--|----------------------------------|--------------------------------|---------------------------|-----------------------------|--------------------------------|------|-----|------|---|----|
| Stainless steel look Inox look | Brushed dark brass Latón cepillado oscuro | Brushed black Negro cepillado | Brushed grey Gris cepillado | Matt white Blanco mate | Metallic grey Gris metal | Metallic brown Marrón metal | | | | | |
| 0372032L24 | 0372032L29 | 0372032L30 | 0372032L31 | 0372032LM1 | 0372032LM23 | 0372032LM41 | 32 | - | 50 | 2 | 25 |
| 0372128L24 | 0372128L29 | 0372128L30 | 0372128L31 | 0372128LM1 | 0372128LM23 | 0372128LM41 | 128 | - | 200 | 2 | 25 |
| 0372256L24 | 0372256L29 | 0372256L30 | 0372256L31 | 0372256LM1 | 0372256LM23 | 0372256LM41 | 256 | - | 350 | 2 | 25 |
| 0372544L24 | 0372544L29 | 0372544L30 | 0372544L31 | 0372544LM1 | 0372544LM23 | 0372544LM41 | 544 | - | 600 | 3 | 25 |
| 03721056L24 | 03721056L29 | 03721056L30 | 03721056L31 | 03721056LM1 | 03721056LM23 | 03721056LM41 | 1056 | 416 | 1100 | 4 | 15 |
| 03721440L24 | 03721440L29 | 03721440L30 | 03721440L31 | 03721440LM1 | 03721440LM23 | 03721440LM41 | 1440 | 480 | 1500 | 4 | 10 |

0375 **VANN** ALUMINIUM Design: Alexis Vivet

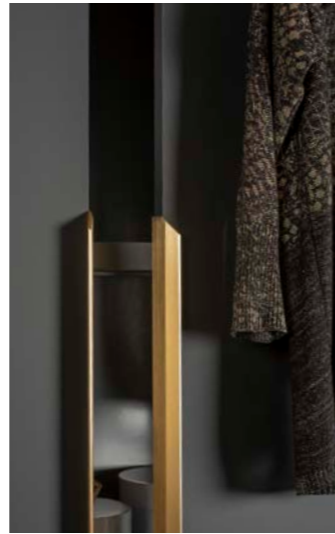
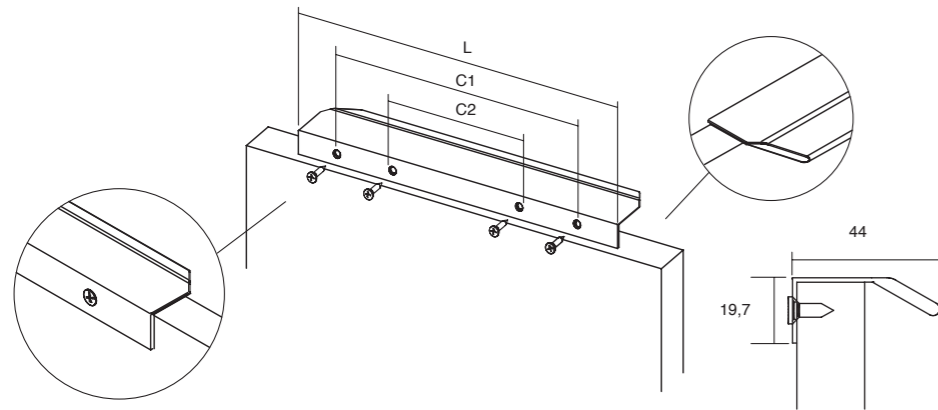

| 02 Anodized bright Anodizado brillo | 04 Anodized matt Anodizado mate | 09 Matt black Negro mate | 24 Stain steel look Inox look | 29 Brushed dark brass Latón oscuro cepill. | C1 | C2 | L | ↓ | ⊞ |
|---|---------------------------------------|--------------------------------|-------------------------------------|--|------|-----|------|---|----|
| 0375064L02 | 0375032L04 | 0375032L09 | 0375032L24 | 0375032L29 | 64 | - | 100 | 2 | 25 |
| 0375128L02 | 0375128L04 | 0375128L09 | 0375128L24 | 0375128L29 | 128 | - | 200 | 2 | 25 |
| 0375256L02 | 0375256L04 | 0375256L09 | 0375256L24 | 0375256L29 | 256 | - | 350 | 2 | 25 |
| - | 03751120L04 | 03751120L09 | 03751120L24 | 03751120L29 | 1120 | 384 | 1200 | 4 | 15 |

0117 **CURVE** ALUMINIUM Design: Viefe®

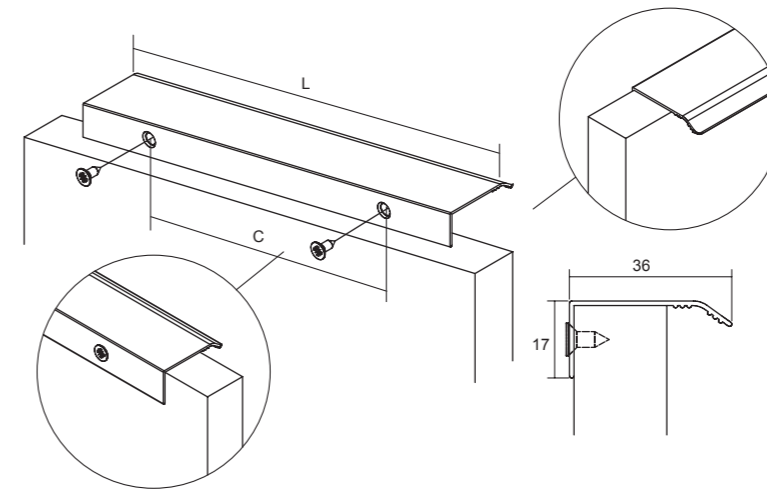

| 04 Anodized matt Anodizado mate | 24 Stainless steel look Inox look | 31 Brushed grey Gris cepillado | M1 Matt white Blanco mate | M2 Matt black Negro mate | C | L | ↓ | ⊞ |
|---------------------------------------|---|--------------------------------------|---------------------------------|--------------------------------|-----|-----|---|----|
| 0117032L04 | 0117032L24 | 0117032L31 | 0117032LM1 | 0117032LM2 | 32 | 45 | 2 | 25 |
| - | 0117064L24 | - | - | - | 64 | 100 | 2 | 25 |
| 0117128L04 | 0117128L24 | 0117128L31 | 0117128LM1 | 0117128LM2 | 128 | 200 | 2 | 25 |
| - | 0117192L24 | - | - | - | 192 | 300 | 2 | 25 |
| - | 0117320L24 | - | - | - | 320 | 400 | 3 | 25 |
| - | 0117416L24 | - | - | - | 416 | 500 | 3 | 25 |

0139 / 0140 **LINEAR** ALUMINIUM Design: Viefe®

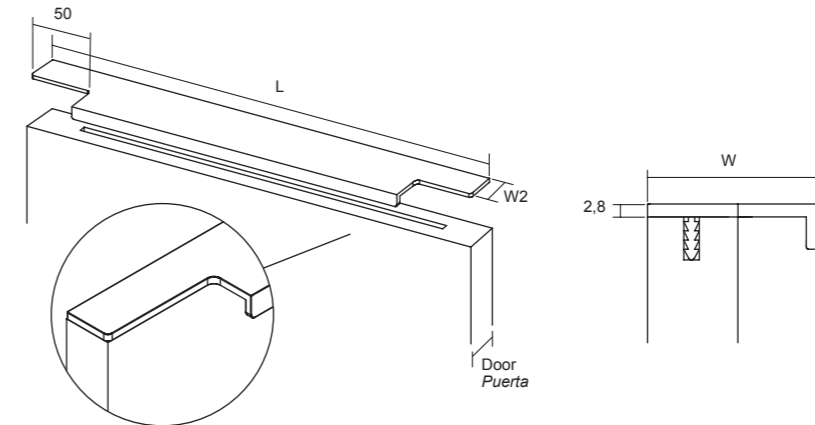

| 24 Stain. steel look Inox look | 30 Brushed black Negro cepillado | L | W (d19) | W2 | Door Puerta | 24 Stain. steel look Inox look | 30 Brushed black Negro cepillado | L | W (d20,5) | W2 | Door Puerta |
|--------------------------------------|--|------|------------|------|----------------|--------------------------------------|--|------|--------------|----|----------------|
| 0139147L24 | 0139147L30 | 147 | 37 | 19,8 | 15 19mm | 0140147L24 | 0140147L30 | 147 | 38,5 | 21 | 15 20,5mm |
| 0139197L24 | 0139197L30 | 197 | 37 | 19,8 | 15 19mm | 0140197L24 | 0140197L30 | 197 | 38,5 | 21 | 15 20,5mm |
| 0139247L24 | 0139247L30 | 247 | 37 | 19,8 | 15 19mm | 0140247L24 | 0140247L30 | 247 | 38,5 | 21 | 15 20,5mm |
| 0139297L24 | 0139297L30 | 297 | 37 | 19,8 | 15 19mm | 0140297L24 | 0140297L30 | 297 | 38,5 | 21 | 15 20,5mm |
| 0139347L24 | 0139347L30 | 347 | 37 | 19,8 | 15 19mm | 0140347L24 | 0140347L30 | 347 | 38,5 | 21 | 15 20,5mm |
| 0139397L24 | 0139397L30 | 397 | 37 | 19,8 | 15 19mm | 0140397L24 | 0140397L30 | 397 | 38,5 | 21 | 15 20,5mm |
| 0139447L24 | 0139447L30 | 447 | 37 | 19,8 | 10 19mm | 0140447L24 | 0140447L30 | 447 | 38,5 | 21 | 10 20,5mm |
| 0139497L24 | 0139497L30 | 497 | 37 | 19,8 | 10 19mm | 0140497L24 | 0140497L30 | 497 | 38,5 | 21 | 10 20,5mm |
| 0139597L24 | 0139597L30 | 597 | 37 | 19,8 | 10 19mm | 0140597L24 | 0140597L30 | 597 | 38,5 | 21 | 10 20,5mm |
| 0139697L24 | 0139697L30 | 697 | 37 | 19,8 | 10 19mm | 0140697L24 | 0140697L30 | 697 | 38,5 | 21 | 10 20,5mm |
| 0139797L24 | 0139797L30 | 797 | 37 | 19,8 | 10 19mm | 0140797L24 | 0140797L30 | 797 | 38,5 | 21 | 10 20,5mm |
| 0139897L24 | 0139897L30 | 897 | 37 | 19,8 | 5 19mm | 0140897L24 | 0140897L30 | 897 | 38,5 | 21 | 5 20,5mm |
| 0139997L24 | 0139997L30 | 997 | 37 | 19,8 | 5 19mm | 0140997L24 | 0140997L30 | 997 | 38,5 | 21 | 5 20,5mm |
| 01391197L24 | 01391197L30 | 1197 | 37 | 19,8 | 5 19mm | 01401197L24 | 01401197L30 | 1197 | 38,5 | 21 | 5 20,5mm |

0322 **CUTT** ALUMINIUM Designer: Alexis Vivet

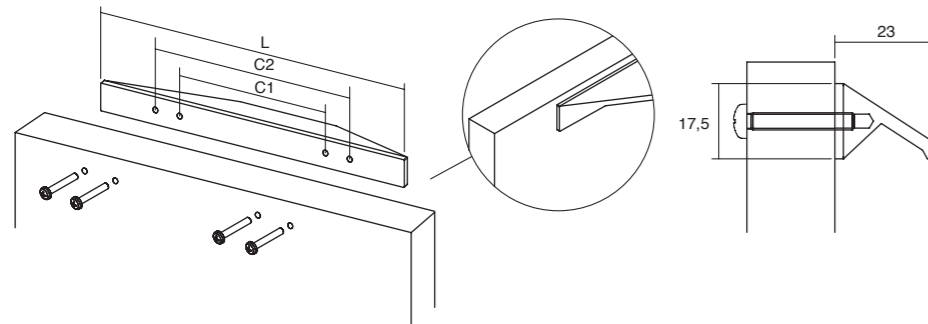

| 01 Polished chrome Cromo brillo | 09 Matt black Negro mate | 24 Stainless steel look Inox look | C1 | C2 | L | ↓ | ⊞ |
|---------------------------------------|--------------------------------|---|-----|------|------|---|----|
| 0322200L01 | 0322200L09 | 0322200L24 | 96 | 128 | 200 | 4 | 25 |
| 0322400L01 | 0322400L09 | 0322400L24 | 192 | 320 | 400 | 4 | 25 |
| 0322600L01 | 0322600L09 | 0322600L24 | 320 | 480 | 600 | 4 | 25 |
| - | 03221000L09 | 03221000L24 | 320 | 896 | 1000 | 4 | 15 |
| - | 03221500L09 | 03221500L24 | 480 | 1376 | 1500 | 4 | 10 |

0434 / 0435 / 0436 **VECTOR** ALUMINIUM Design: Viefe®



| 24 S. steel look Inox look | 30 Brushed black Negro cepillado | 31 Brushed grey Gris cepillado | L | W1 | W2 | Door Puerta |
|----------------------------------|--|--------------------------------------|------|----|------|----------------|
| 0434147L24 | 0434147L30 | 0434147L31 | 147 | 41 | 19,8 | 15 19 |
| 0434197L24 | 0434197L30 | 0434197L31 | 197 | 41 | 19,8 | 15 19 |
| 0434247L24 | 0434247L30 | 0434247L31 | 247 | 41 | 19,8 | 15 19 |
| 0434297L24 | 0434297L30 | 0434297L31 | 297 | 41 | 19,8 | 15 19 |
| 0434347L24 | 0434347L30 | 0434347L31 | 347 | 41 | 19,8 | 15 19 |
| 0434397L24 | 0434397L30 | 0434397L31 | 397 | 41 | 19,8 | 15 19 |
| 0434447L24 | 0434447L30 | 0434447L31 | 447 | 41 | 19,8 | 10 19 |
| 0434497L24 | 0434497L30 | 0434497L31 | 497 | 41 | 19,8 | 10 19 |
| 0434597L24 | 0434597L30 | 0434597L31 | 597 | 41 | 19,8 | 10 19 |
| 0434697L24 | 0434697L30 | 0434697L31 | 697 | 41 | 19,8 | 10 19 |
| 0434797L24 | 0434797L30 | 0434797L31 | 797 | 41 | 19,8 | 10 19 |
| 0434897L24 | 0434897L30 | 0434897L31 | 897 | 41 | 19,8 | 5 19 |
| 0434997L24 | 0434997L30 | 0434997L31 | 997 | 41 | 19,8 | 5 19 |
| 04341197L24 | 04341197L30 | 04341197L31 | 1197 | 41 | 19,8 | 5 19 |

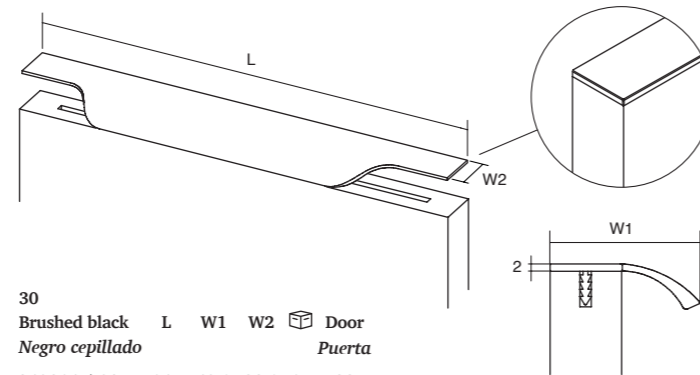

| 24 S. steel look Inox look | 30 Brushed black Negro cepillado | L | W1 | W2 | Door Puerta | 24 S. steel look Inox look | 30 Brushed black Negro cepillado | L | W1 | W2 | Door Puerta |
|----------------------------------|--|------|------|----|----------------|----------------------------------|--|------|------|------|----------------|
| 0435147L24 | 0435147L30 | 147 | 43,8 | 21 | 15 20,5 | 0436147L24 | 0436147L30 | 147 | 43,8 | 22,8 | 15 22 |
| 0435197L24 | 0435197L30 | 197 | 43,8 | 21 | 15 20,5 | 0436197L24 | 0436197L30 | 197 | 43,8 | 22,8 | 15 22 |
| 0435247L24 | 0435247L30 | 247 | 43,8 | 21 | 15 20,5 | 0436247L24 | 0436247L30 | 247 | 43,8 | 22,8 | 15 22 |
| 0435297L24 | 0435297L30 | 297 | 43,8 | 21 | 15 20,5 | 0436297L24 | 0436297L30 | 297 | 43,8 | 22,8 | 15 22 |
| 0435347L24 | 0435347L30 | 347 | 43,8 | 21 | 15 20,5 | 0436347L24 | 0436347L30 | 347 | 43,8 | 22,8 | 15 22 |
| 0435397L24 | 0435397L30 | 397 | 43,8 | 21 | 15 20,5 | 0436397L24 | 0436397L30 | 397 | 43,8 | 22,8 | 15 22 |
| 0435447L24 | 0435447L30 | 447 | 43,8 | 21 | 10 20,5 | 0436447L24 | 0436447L30 | 447 | 43,8 | 22,8 | 10 22 |
| 0435497L24 | 0435497L30 | 497 | 43,8 | 21 | 10 20,5 | 0436497L24 | 0436497L30 | 497 | 43,8 | 22,8 | 10 22 |
| 0435597L24 | 0435597L30 | 597 | 43,8 | 21 | 10 20,5 | 0436597L24 | 0436597L30 | 597 | 43,8 | 22,8 | 10 22 |
| 0435697L24 | 0435697L30 | 697 | 43,8 | 21 | 10 20,5 | 0436697L24 | 0436697L30 | 697 | 43,8 | 22,8 | 10 22 |
| 0435797L24 | 0435797L30 | 797 | 43,8 | 21 | 10 20,5 | 0436797L24 | 0436797L30 | 797 | 43,8 | 22,8 | 10 22 |
| 0435897L24 | 0435897L30 | 897 | 43,8 | 21 | 5 20,5 | 0436897L24 | 0436897L30 | 897 | 43,8 | 22,8 | 5 22 |
| 0435997L24 | 0435997L30 | 997 | 43,8 | 21 | 5 20,5 | 0436997L24 | 0436997L30 | 997 | 43,8 | 22,8 | 5 22 |
| 04351197L24 | 04351197L30 | 1197 | 43,8 | 21 | 5 20,5 | 04361197L24 | 04361197L30 | 1197 | 43,8 | 22,8 | 5 22 |

0250 / 0251 / 0253 **FORMA** ALUMINIUM Design: 2J Design

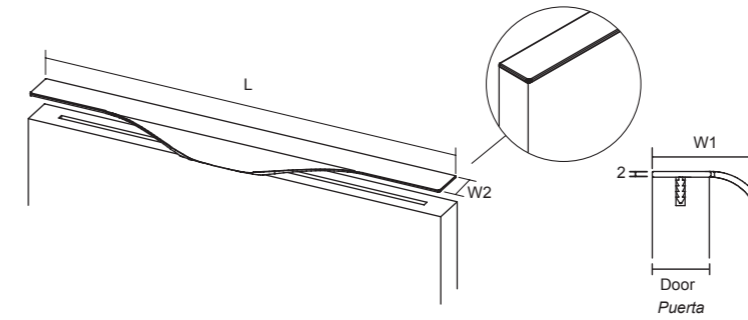

| 24 Stain. steel look Inox look | L | W1 | W2 | Door Puerta | 24 Stain. steel look Inox look | L | W1 | W2 | Door Puerta | 24 Stain. steel look Inox look | L | W1 | W2 | Door Puerta |
|--------------------------------------|------|----|------|----------------|--------------------------------------|------|----|----|----------------|--------------------------------------|------|----|------|----------------|
| 0250147L24 | 147 | 38 | 19,8 | 15 19 | 0251147L24 | 147 | 40 | 21 | 15 20,5 | 0253147L24 | 147 | 40 | 22,8 | 15 22 |
| 0250197L24 | 197 | 38 | 19,8 | 15 19 | 0251197L24 | 197 | 40 | 21 | 15 20,5 | 0253197L24 | 197 | 40 | 22,8 | 15 22 |
| 0250247L24 | 247 | 38 | 19,8 | 15 19 | 0251247L24 | 247 | 40 | 21 | 15 20,5 | 0253247L24 | 247 | 40 | 22,8 | 15 22 |
| 0250297L24 | 297 | 38 | 19,8 | 15 19 | 0251297L24 | 297 | 40 | 21 | 15 20,5 | 0253297L24 | 297 | 40 | 22,8 | 15 22 |
| 0250347L24 | 347 | 38 | 19,8 | 15 19 | 0251347L24 | 347 | 40 | 21 | 15 20,5 | 0253347L24 | 347 | 40 | 22,8 | 15 22 |
| 0250397L24 | 397 | 38 | 19,8 | 15 19 | 0251397L24 | 397 | 40 | 21 | 15 20,5 | 0253397L24 | 397 | 40 | 22,8 | 15 22 |
| 0250447L24 | 447 | 38 | 19,8 | 10 19 | 0251447L24 | 447 | 40 | 21 | 10 20,5 | 0253447L24 | 447 | 40 | 22,8 | 10 22 |
| 0250497L24 | 497 | 38 | 19,8 | 10 19 | 0251497L24 | 497 | 40 | 21 | 10 20,5 | 0253497L24 | 497 | 40 | 22,8 | 10 22 |
| 0250597L24 | 597 | 38 | 19,8 | 10 19 | 0251597L24 | 597 | 40 | 21 | 10 20,5 | 0253597L24 | 597 | 40 | 22,8 | 10 22 |
| 0250697L24 | 697 | 38 | 19,8 | 10 19 | 0251697L24 | 697 | 40 | 21 | 10 20,5 | 0253697L24 | 697 | 40 | 22,8 | 10 22 |
| 0250797L24 | 797 | 38 | 19,8 | 10 19 | 0251797L24 | 797 | 40 | 21 | 10 20,5 | 0253797L24 | 797 | 40 | 22,8 | 10 22 |
| 0250897L24 | 897 | 38 | 19,8 | 5 19 | 0251897L24 | 897 | 40 | 21 | 5 20,5 | 0253897L24 | 897 | 40 | 22,8 | 5 22 |
| 0250997L24 | 997 | 38 | 19,8 | 5 19 | 0251997L24 | 997 | 40 | 21 | 5 20,5 | 0253997L24 | 997 | 40 | 22,8 | 5 22 |
| 02501197L24 | 1197 | 38 | 19,8 | 5 19 | 02511197L24 | 1197 | 40 | 21 | 5 20,5 | 02531197L24 | 1197 | 40 | 22,8 | 5 22 |

0254/0255 **NOMA** ALUMINIUM Design: 2J Design

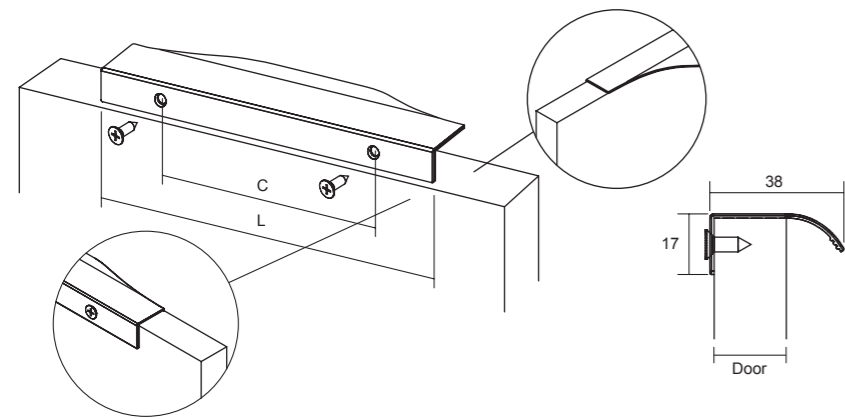

| 02 Anodized bright Anodizado brillo | 24 Stainless steel look Inox look | 30 NEW! Brushed black Negro cepillado | 613 Antique bronze Bronze antiguo | 618 NEW! Brushed brass cava Latón cava cepillado | C | L | ↓ | Door Puerta |
|---|---|---|---|--|-----|-----|---|----------------|
| 0254128L02 | 0254128L24 | 0254128L30 | 0254128L613 | 0254128L618 | 128 | 200 | 2 | 25 19 |
| 0254256L02 | 0254256L24 | 0254256L30 | 0254256L613 | 0254256L618 | 256 | 350 | 2 | 25 19 |
| - | 0255128L24 | - | - | - | 128 | 200 | 2 | 25 22 |
| - | 0255256L24 | - | - | - | 256 | 350 | 2 | 25 22 |

0334 **BRIKK** ALUMINIUM Design: Alexis Vivet

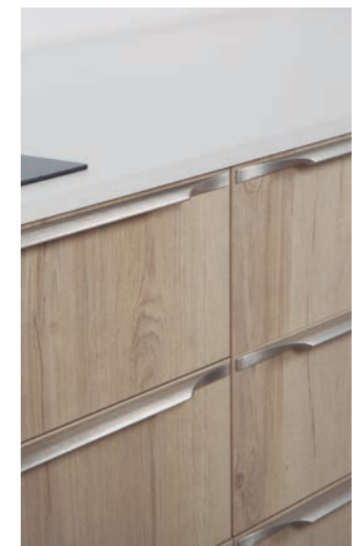
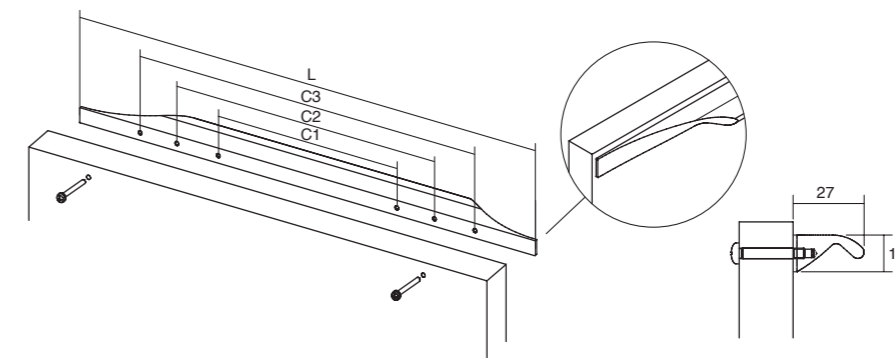

| 24 Stainless steel look Inox look | 613 Antique bronze bronce antiguo | C1 | C2 | C3 | L | ↓ | Door |
|---|---|-----|-----|------|------|---|------|
| 0334140L24 | 0334140L613 | 32 | - | - | 140 | 2 | 15 |
| 0334190L24 | - | 64 | - | - | 190 | 2 | 15 |
| 0334240L24 | - | 96 | - | - | 240 | 2 | 15 |
| 0334290L24 | 0334290L613 | 160 | - | - | 290 | 2 | 15 |
| 0334340L24 | - | 192 | - | - | 340 | 2 | 15 |
| 0334390L24 | - | 128 | 260 | - | 390 | 4 | 15 |
| 0334440L24 | - | 160 | 310 | - | 440 | 4 | 10 |
| 0334490L24 | 0334490L613 | 192 | 360 | - | 490 | 4 | 10 |
| 0334590L24 | - | 224 | 460 | - | 590 | 4 | 10 |
| 0334690L24 | - | 256 | 560 | - | 690 | 4 | 10 |
| 0334790L24 | - | 320 | 660 | - | 790 | 4 | 10 |
| 0334890L24 | - | 384 | 760 | - | 890 | 4 | 5 |
| 0334990L24 | - | 320 | 640 | 860 | 990 | 6 | 5 |
| 03341190L24 | 03341190L613 | 320 | 832 | 1060 | 1190 | 6 | 5 |

0379 / 0380 / 0382

STEEP

ALUMINIUM

Design: Viefe®

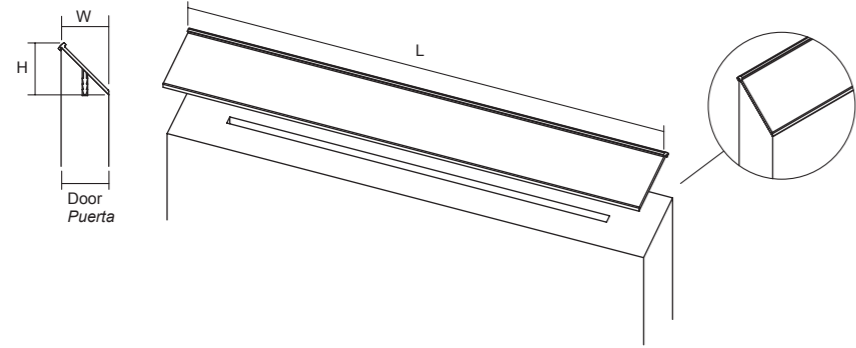

| 02 | 24 | M2 | L | W | H | Door |
|-------------------------------------|-----------------------------------|--------------------------|------|------|------|----------|
| Anodized bright Anodizado brillo | Stainless steel look Inox look | Matt black Negro mate | | | | Puerta |
| 03793000L02 | - | - | 3000 | 17,5 | 18,5 | 15 16 |
| 03803000L02 | 03803000L24 | 03803000LM2 | 3000 | 21 | 21,8 | 15 18-19 |
| - | 03823000L24 | - | 3000 | 24 | 24,8 | 15 22 |

0108

TWISTED

ZAMAK

Design: Viefe®

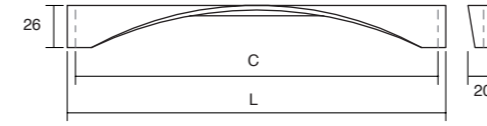

| 01 | 23 | C | L | ↓ | ☐ |
|---------------------------------|------------------------------------|-----|-----|---|----|
| Polished chrome Cromo brillo | Brushed nickel Níquel cepillado | | | | |
| 0108160Z01 | 0108160Z23 | 160 | 170 | 2 | 25 |
| 0108224Z01 | 0108224Z23 | 224 | 234 | 2 | 25 |
| 0108320Z01 | 0108320Z23 | 320 | 340 | 2 | 25 |

0239

ARA

ALUMINIUM

Design: 2J Design

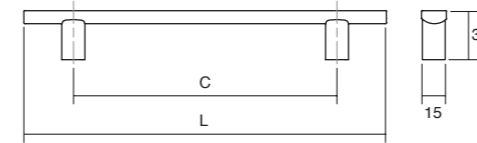

| 24 | C | L | ↓ | ☐ |
|--------------------------------|-----|-----|---|----|
| Stain. steel look Inox look | | | | |
| 0239096L24 | 96 | 156 | 2 | 25 |
| 0239192L24 | 192 | 252 | 2 | 25 |
| 0239320L24 | 320 | 380 | 2 | 25 |

0343

GRADA

ALUMINIUM

Design: Viefe®

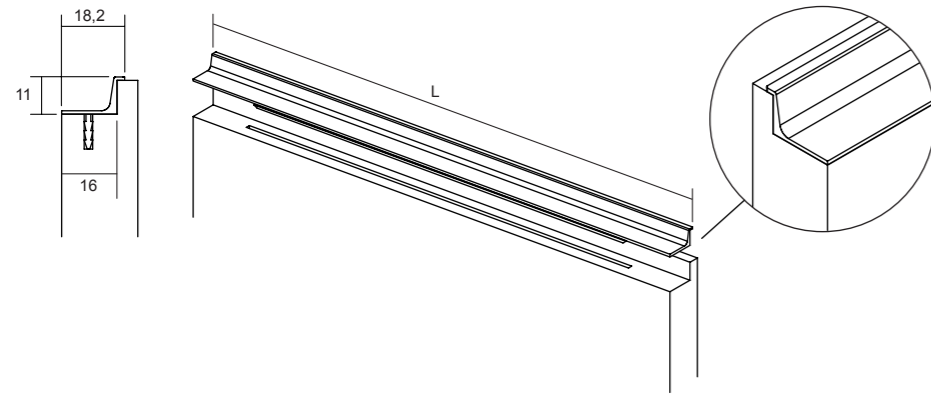

| 02 | 04 | 24 | M1 | M2 | L | ☐ |
|-------------------------------------|---------------------------------|-----------------------------------|---------------------------|--------------------------|------|----|
| Anodized bright Anodizado brillo | Anodized matt Anodizado mate | Stainless steel look Inox look | Matt white Blanco mate | Matt black Negro mate | | |
| - | 0343147L04 | 0343147L24 | 0343147LM1 | 0343147LM2 | 147 | 15 |
| - | 0343197L04 | 0343197L24 | 0343197LM1 | 0343197LM2 | 197 | 15 |
| - | 0343247L04 | 0343247L24 | 0343247LM1 | 0343247LM2 | 247 | 15 |
| - | 0343297L04 | 0343297L24 | 0343297LM1 | 0343297LM2 | 297 | 15 |
| - | 0343347L04 | 0343347L24 | 0343347LM1 | 0343347LM2 | 347 | 15 |
| - | 0343397L04 | 0343397L24 | 0343397LM1 | 0343397LM2 | 397 | 15 |
| - | 0343447L04 | 0343447L24 | 0343447LM1 | 0343447LM2 | 447 | 10 |
| - | 0343497L04 | 0343497L24 | 0343497LM1 | 0343497LM2 | 497 | 10 |
| - | 0343597L04 | 0343597L24 | 0343597LM1 | 0343597LM2 | 597 | 10 |
| - | 0343697L04 | 0343697L24 | 0343697LM1 | 0343697LM2 | 697 | 10 |
| - | 0343797L04 | 0343797L24 | 0343797LM1 | 0343797LM2 | 797 | 10 |
| - | 0343897L04 | 0343897L24 | 0343897LM1 | 0343897LM2 | 897 | 5 |
| - | 0343997L04 | 0343997L24 | 0343997LM1 | 0343997LM2 | 997 | 5 |
| - | 03431197L04 | 03431197L24 | 03431197LM1 | 03431197LM2 | 1197 | 5 |
| 03433000L02 | 03433000L04 | 03433000L24 | 03433000LM1 | 03433000LM2 | 3000 | 15 |

0219

ARROW

ZAMAK

Design: 2J Design

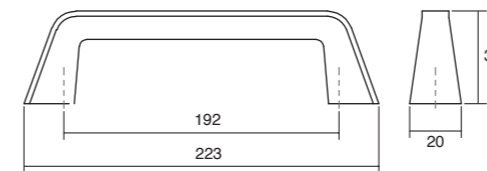

| 01 | 23 | ↓ | ☐ |
|---------------------------------|------------------------------------|---|----|
| Polished chrome Cromo brillo | Brushed nickel Níquel cepillado | | |
| 0219192Z01 | 0219192Z23 | 2 | 25 |

0374 **BALL** ZAMAK Design: Alexis Vivet

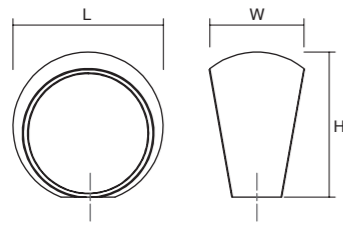

| 01 | 23 | 27 | L | W | H | ↓ | ☐ |
|--|---|---|------|------|------|---|----|
| Polished chrome <i>Cromo brillo</i> | Brushed nickel <i>Níquel cepillado</i> | Brushed brass <i>Latón cepillado</i> | | | | | |
| 0374024Z01 | 0374024Z23 | 0374024Z27 | 23,3 | 14,8 | 22,8 | 1 | 25 |
| 0374029Z01 | 0374029Z23 | 0374029Z27 | 29,5 | 18,3 | 28,8 | 1 | 25 |

0226 **REDO** ZAMAK Design: 2J Design

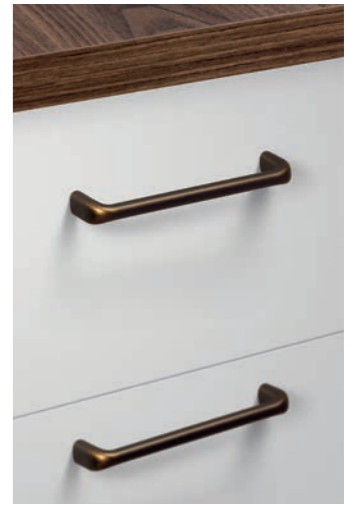
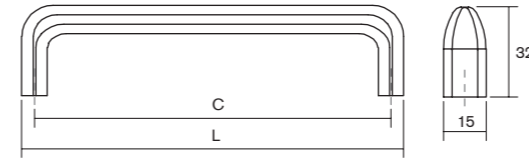

| 01 | 23 | 26 | 610 | 614 | C | L | ↓ | ☐ |
|--|---|--|-------------------------|---------------------------------------|-----|-----|---|----|
| Polished chrome <i>Cromo brillo</i> | Brushed nickel <i>Níquel cepillado</i> | Brushed copper <i>Cobre cepillado</i> | Pewter <i>Peltre</i> | Antique Brass <i>Latón antiguo</i> | | | | |
| 0226128Z01 | 0226128Z23 | 0226128Z26 | 0226128Z610 | 0226128Z614 | 128 | 137 | 2 | 25 |
| 0226192Z01 | 0226192Z23 | 0226192Z26 | 0226192Z610 | 0226192Z614 | 192 | 201 | 2 | 25 |

0410 **BUTTON** ZAMAK Design: Alexis Vivet

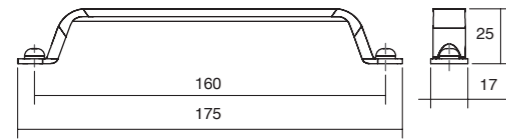

| 01 | 610 | 614 | M2 | ↓ | ☐ |
|--|-------------------------|---------------------------------------|---------------------------------|---|----|
| Polished chrome <i>Cromo brillo</i> | Pewter <i>Peltre</i> | Antique Brass <i>Latón antiguo</i> | Matt black <i>Negro mate</i> | | |
| 0410160Z01 | 0410160Z610 | 0410160Z614 | 0410160ZM2 | 2 | 25 |

0411 **VERSO** ZAMAK Design: Teruel & Paré

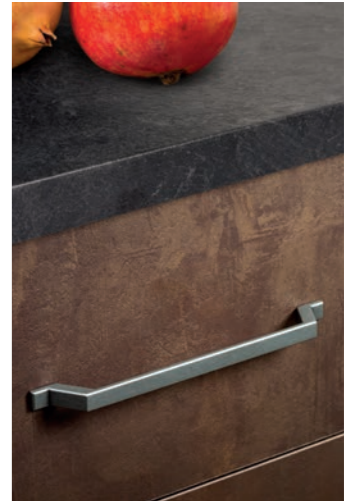
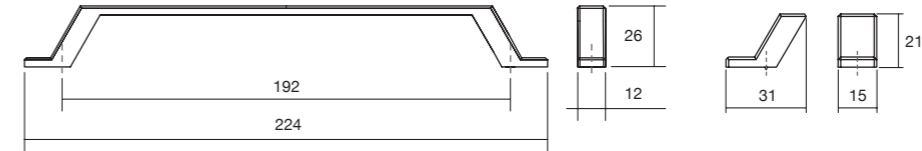

| 01 | 23 | 610 | 614 | ↓ | ☐ |
|--|---|-------------------------|---------------------------------------|---|----|
| Polished chrome <i>Cromo brillo</i> | Brushed nickel <i>Níquel cepillado</i> | Pewter <i>Peltre</i> | Antique Brass <i>Latón antiguo</i> | | |
| 04111015Z01 | 04111015Z23 | 04111015Z610 | 04111015Z614 | 1 | 25 |
| 0411192Z01 | 0411192Z23 | 0411192Z610 | 0411192Z614 | 2 | 25 |

0393 **DUKE** ZAMAK Design: Viefé®

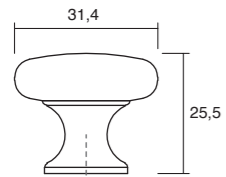

| 01 | 23 | 26 | 27 | 66 | 610 | 612 | 614 | M1 | M2 | ↓ | ☐ |
|------------------------------------|---|--|---|--|-------------------------|--|---------------------------------------|----------------------------------|---------------------------------|---|----|
| Pol. chrome <i>Cromo brillo</i> | Brushed nickel <i>Níquel cepill.</i> | Brushed copper <i>Cobre cepillado</i> | Brushed brass <i>Latón cepillado</i> | Antique copper <i>Cobre antiguo</i> | Pewter <i>Peltre</i> | Antique silver <i>Plata antigua</i> | Antique Brass <i>Latón antiguo</i> | Matt white <i>Blanco mate</i> | Matt black <i>Negro mate</i> | | |
| 0393031Z01 | 0393031Z23 | 0393031Z26 | 0393031Z27 | 0393031Z66 | 0393031Z610 | 0393031Z612 | 0393031Z614 | 0393031ZM1 | 0393031ZM2 | 1 | 25 |

0405 **RAVIOLO** ZAMAK Design: Balutto Associati

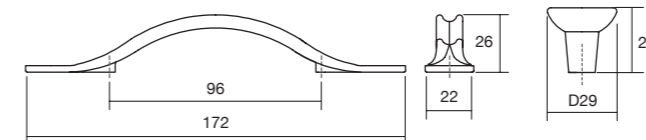

| 610 | 614 | ↓ | ☐ |
|-------------------------|---------------------------------------|---|----|
| Pewter <i>Peltre</i> | Antique Brass <i>Latón antiguo</i> | | |
| 0405029Z610 | 0405029Z614 | 1 | 25 |
| 0405096Z610 | 0405096Z614 | 2 | 25 |

0394 **AVA** ZAMAK Design: Viefe®

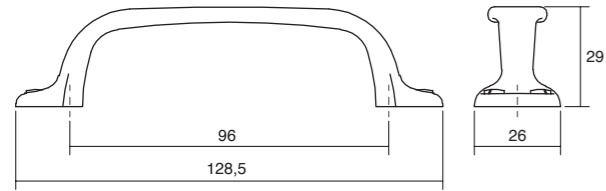

01 Polished Chrome Cromo brillo
610 Pewter Peltre
614 Antique Brass Latón antiguo

0394096Z01 0394096Z610 0394096Z614 2 25



0391 **AURA** ZAMAK Design: Viefe®

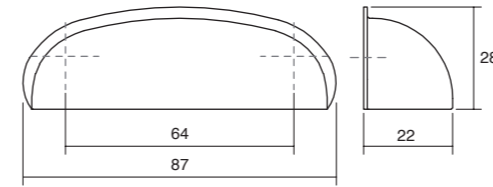

66 Antique copper Cobre antiguo
612 Antique silver Plata antigua

0391064Z66 0391064Z612 2 25

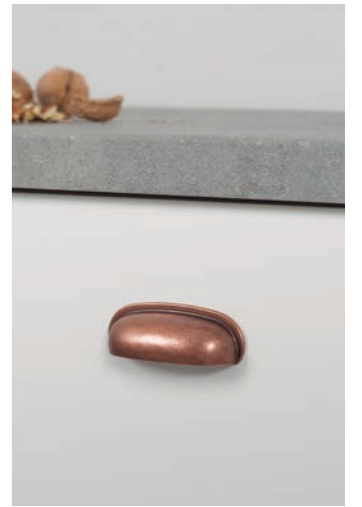

0390 **PETRA** ZAMAK Design: Viefe®

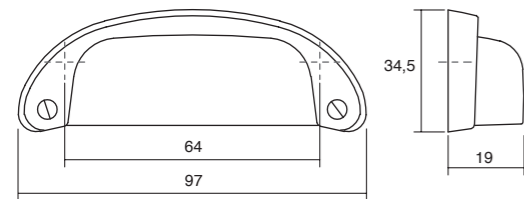

66 Antique copper Cobre antiguo
612 Antique silver Plata antigua
M2 Matt black Negro mate

0390064Z66 0390064Z612 0390064ZM2 2 25



0404 **FLEXA** LEATHER + ZAMAK Design: Balutto Associati

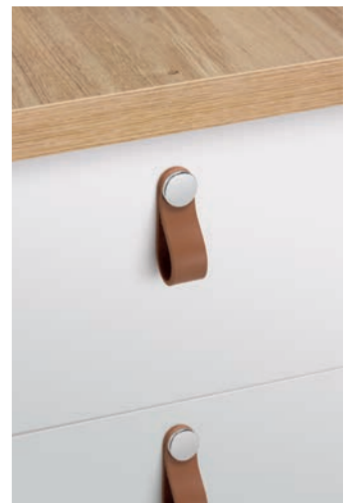
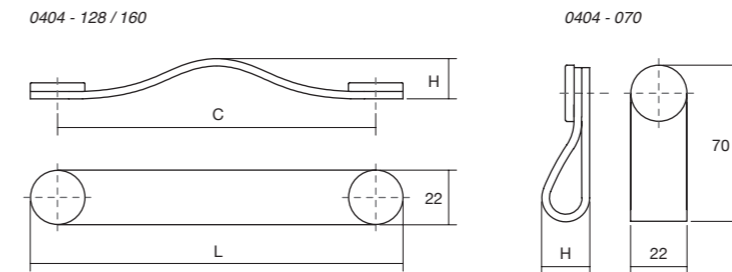

0392 **ORION** ZAMAK Design: Viefe®



66 Antique copper Cobre antiguo
612 Antique silver Plata antigua

0392128Z66 0392128Z612 2 25

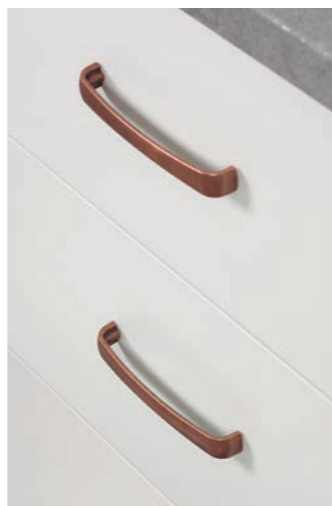

| | 26 Beige / Beige | 36 Brown / Marrón | 99 Black / Negro | C | L | H | ↓ | ☐ |
|-----------------------------------|---------------------|----------------------|---------------------|-----|-----|----|---|----|
| 01 Polished chrome / Cromo brillo | 0404070P2601 | 0404070P3601 | 0404070P9901 | - | 70 | 24 | 1 | 25 |
| 01 Polished chrome / Cromo brillo | 0404128P2601 | 0404128P3601 | 0404128P9901 | 128 | 150 | 25 | 2 | 25 |
| 01 Polished chrome / Cromo brillo | 0404160P2601 | 0404160P3601 | 0404160P9901 | 160 | 182 | 27 | 2 | 25 |
| 610 Pewter / Peltre | 0404070P2610 | 0404070P3610 | 0404070P9910 | - | 70 | 24 | 1 | 25 |
| 610 Pewter / Peltre | 0404128P2610 | 0404128P3610 | 0404128P9910 | 128 | 150 | 25 | 2 | 25 |
| 610 Pewter / Peltre | 0404160P2610 | 0404160P3610 | 0404160P9910 | 160 | 182 | 27 | 2 | 25 |
| M2 Black / Negro | 0404070P26M2 | 0404070P36M2 | 0404070P99M2 | - | 70 | 24 | 1 | 25 |
| M2 Black / Negro | 0404128P26M2 | 0404128P36M2 | 0404128P99M2 | 128 | 150 | 25 | 2 | 25 |
| M2 Black / Negro | 0404160P26M2 | 0404160P36M2 | 0404160P99M2 | 160 | 182 | 27 | 2 | 25 |
| 27 Brass / Latón | 0404070P2627 | 0404070P3627 | 0404070P9927 | - | 70 | 24 | 1 | 25 |
| 27 Brass / Latón | 0404128P2627 | 0404128P3627 | 0404128P9927 | 128 | 150 | 25 | 2 | 25 |
| 27 Brass / Latón | 0404160P2627 | 0404160P3627 | 0404160P9927 | 160 | 182 | 27 | 2 | 25 |

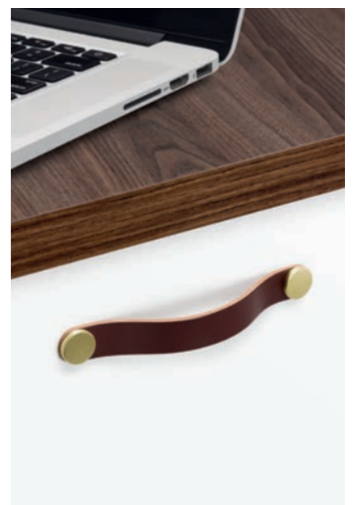

0239 **ARA W** ALUMINIUM + WOOD Design: 2J Design

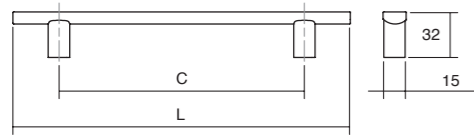

| 24 + 16 | 24 + 17 | C | L | ↓ | ☐ |
|---|--|-----|-----|---|----|
| Stainless steel look + Oak Inox look + Roble | Stainless steel look + Walnut Inox look + Nogal | | | | |
| 0239160N2416 | 0239160N2417 | 160 | 220 | 2 | 25 |
| 0239224N2416 | 0239224N2417 | 224 | 284 | 2 | 25 |



0326 **TACCO** WOOD Design: Alexis Vivet

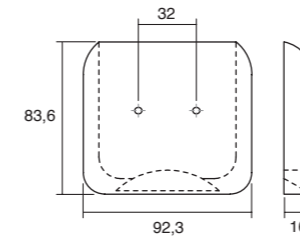

| 18 | 19 | 00 | ↓ | ☐ |
|---------------|-----------------|-------------------------|---|----|
| Ash Fresno | Walnut Nogal | Beech raw Haya crudo | | |
| 0326032W18 | 0326032W19 | 0326032W00 | 2 | 25 |



0340 **BARCCO** WOOD Design: Alexis Vivet

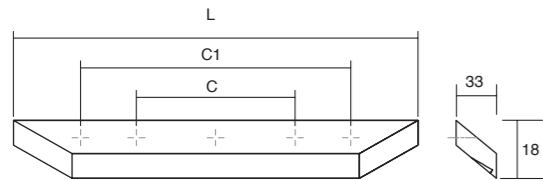

| 18 | 19 | 00 | C | C1 | L | ↓ | ☐ |
|---------------|-----------------|-------------------------|-----|-----|-----|---|----|
| Ash Fresno | Walnut Nogal | Beech raw Haya crudo | | | | | |
| 0340200W18 | 0340200W19 | 0340200W00 | 160 | - | 200 | 3 | 25 |
| 0340400W18 | 0340400W19 | 0340400W00 | 320 | - | 400 | 3 | 25 |
| 0340600W18 | 0340600W19 | 0340600W00 | 320 | 480 | 600 | 4 | 25 |

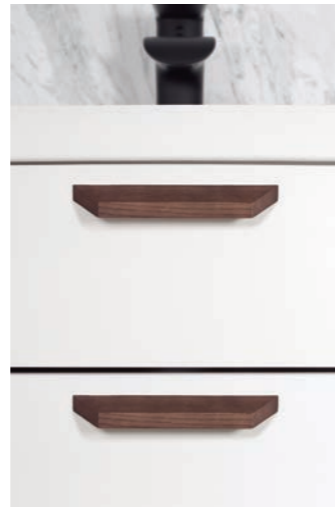

0166 **ECHO** WOOD Design: Viefe®

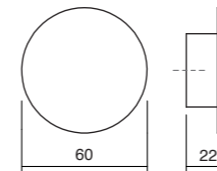

| 00 | 02 | 08 | 09 | ↓ | ☐ |
|--------------------------------|-----------------------------------|-----------------------------------|----------------------------------|---|----|
| Raw brushed Crudo cepillado | White brushed Blanco cepillado | Brown brushed Marrón cepillado | Black brushed Negro cepillado | | |
| 0166060W00 | 0166060W02 | 0166060W08 | 0166060W09 | 1 | 25 |



0165 **CALIN** WOOD Design: Viefe®

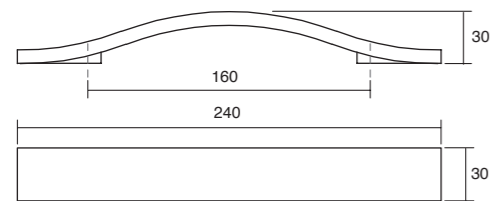

| 00 | 02 | 08 | 09 | ↓ | ☐ |
|--------------------------------|-----------------------------------|-----------------------------------|----------------------------------|---|----|
| Raw brushed Crudo cepillado | White brushed Blanco cepillado | Brown brushed Marrón cepillado | Black brushed Negro cepillado | | |
| 0165160W00 | 0165160W02 | 0165160W08 | 0165160W09 | 2 | 25 |



0167 **BALTO** WOOD Design: Viefe®

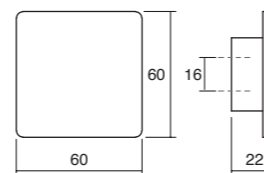

| 00 | 02 | 08 | 09 | ↓ | ☐ |
|--------------------------------|-----------------------------------|-----------------------------------|----------------------------------|---|----|
| Raw brushed Crudo cepillado | White brushed Blanco cepillado | Brown brushed Marrón cepillado | Black brushed Negro cepillado | | |
| 0167016W00 | 0167016W02 | 0167016W08 | 0167016W09 | 2 | 25 |



0281 **FLAT** ZAMAK

Design: Oriol Barri

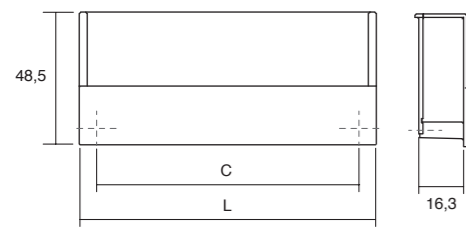

| 01 | 23 | | | | | |
|---------------------|-------------------------|-----|-------|---|----|--|
| Polished chrome | Brushed nickel | C | L | ↓ | ☐ | |
| <i>Cromo brillo</i> | <i>Níquel cepillado</i> | | | | | |
| 0281160Z01 | 0281160Z23 | 160 | 174,8 | 2 | 25 | |



0091 **RASO** ZAMAK

Design: Viefe®

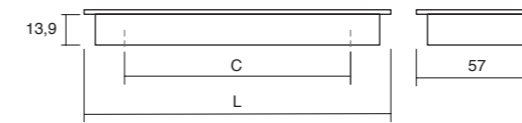

| 23 | | | | | | |
|-------------------------|-----|-------|---|----|--|--|
| Brushed nickel | C | L | ↓ | ☐ | | |
| <i>Níquel cepillado</i> | | | | | | |
| 0091032Z23 | 32 | 70 | 2 | 25 | | |
| 0091108Z23 | 108 | 152,5 | 2 | 25 | | |



0243 **LOW ST** ZAMAK

Design: Viefe®

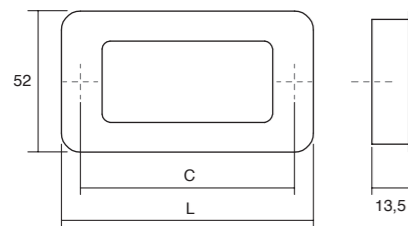

| 01 | 23 | | | | | |
|---------------------|-------------------------|-----|-----|---|----|--------------------------------------|
| Polished chrome | Brushed nickel | C | L | ↓ | ☐ | |
| <i>Cromo brillo</i> | <i>Níquel cepillado</i> | | | | | |
| 0243064Z01ST | 0243064Z23ST | 64 | 78 | 2 | 25 | With backplate / Con placa posterior |
| 0243192Z01ST | 0243192Z23ST | 192 | 206 | 2 | 25 | With backplate / Con placa posterior |



0208 **DUA** ZAMAK

Design: Viefe®

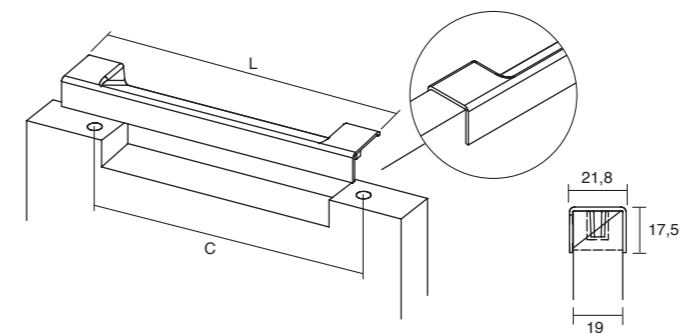

| 01 | 23 | | | | | |
|---------------------|-------------------------|-----|-----|---|----|---------------|
| Polished chrome | Brushed nickel | C | L | ↓ | ☐ | Door |
| <i>Cromo brillo</i> | <i>Níquel cepillado</i> | | | | | <i>Puerta</i> |
| 0208192Z01 | 0208192Z23 | 192 | 210 | 2 | 25 | 19mm |



0204 **RADI** STAINLESS STEEL

Design: Viefe®

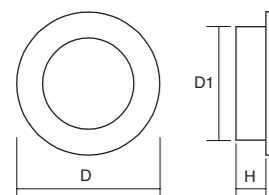

| 25 | | | | | | |
|-----------------------|----|----|----|----|---|--|
| Brushed stain. steel | D | D1 | H | ↓ | ☐ | |
| <i>Inox cepillado</i> | | | | | | |
| 0204050S25 | 50 | 40 | 12 | 25 | | |
| 0204065S25 | 65 | 55 | 14 | 25 | | |



0376 **BOXX** ZAMAK

Design: Alexis Vivet

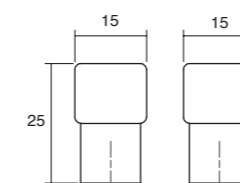

| 01 | 11 | 23 | M2 | | | |
|---------------------|-------------------|-------------------------|-------------------|---|----|--|
| Polished chrome | Matt chrome | Brushed nickel | Matt black | ↓ | ☐ | |
| <i>Cromo brillo</i> | <i>Cromo mate</i> | <i>Níquel cepillado</i> | <i>Negro mate</i> | | | |
| 0376012Z01 | 0376012Z11 | 0376012Z23 | 0376012ZM2 | 1 | 25 | |



0369 **RITTA** ALUMINIUM Design: Teruel & Paré

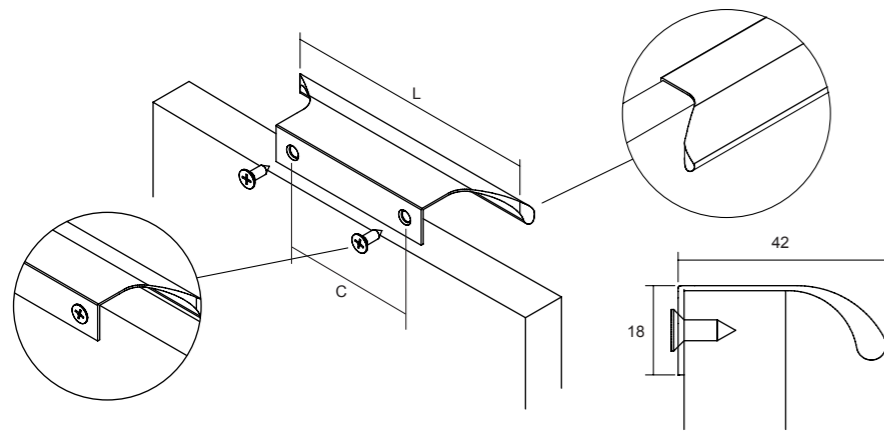

| 01 | 09 | 24 | C | L | ↓ | ☐ |
|-----------------|------------|----------------------|-----|-----|---|----|
| Polished chrome | Matt black | Stainless steel look | | | | |
| Cromo brillo | Negro mate | Inox look | | | | |
| 0369064L01 | 0369064L09 | 0369064L24 | 64 | 130 | 2 | 25 |
| 0369128L01 | 0369128L09 | 0369128L24 | 128 | 260 | 2 | 25 |

0076 **FORT** STAINLESS STEEL Design: Viefe®

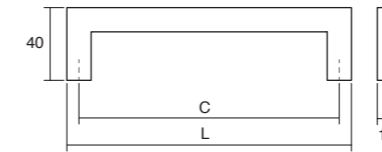

| 25 | C | L | ↓ | ☐ |
|-------------------------|-----|-----|---|----|
| Brushed stainless steel | | | | |
| Acero inox. cepillado | | | | |
| 0076128S25 | 128 | 143 | 2 | 25 |
| 0076160S25 | 160 | 175 | 2 | 25 |
| 0076192S25 | 192 | 207 | 2 | 25 |
| 0076256S25 | 256 | 271 | 2 | 25 |
| 0076320S25 | 320 | 335 | 2 | 25 |
| 0076392S25 | 392 | 407 | 2 | 25 |
| 0076492S25 | 492 | 507 | 2 | 25 |
| 0076592S25 | 592 | 607 | 2 | 25 |
| 0076692S25 | 692 | 707 | 2 | 10 |



0249 **FERRI** STAINLESS STEEL Design: Viefe®

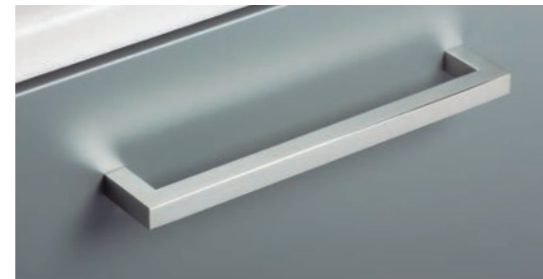
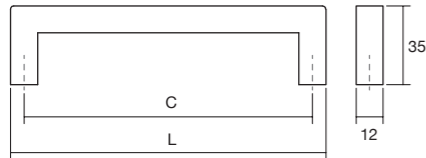

| 25 | C | L | ↓ | ☐ |
|-------------------------|-----|-----|---|----|
| Brushed stainless steel | | | | |
| Inox cepillado | | | | |
| 0249128S25 | 128 | 140 | 2 | 25 |
| 0249160S25 | 160 | 172 | 2 | 25 |
| 0249192S25 | 192 | 204 | 2 | 25 |
| 0249320S25 | 320 | 332 | 2 | 25 |
| 0249512S25 | 512 | 524 | 2 | 25 |

0312 **ARKO** ALUMINIUM Design: Viefe®

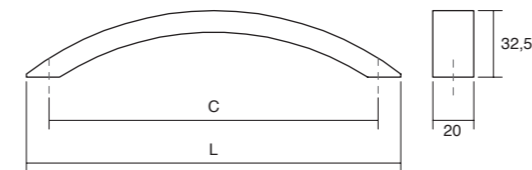

| 24 | C | L | ↓ | ☐ |
|-------------------|-----|-----|---|----|
| Stain. steel look | | | | |
| Inox look | | | | |
| 0312160L24 | 160 | 186 | 2 | 25 |
| 0312192L24 | 192 | 218 | 2 | 25 |
| 0312256L24 | 256 | 292 | 2 | 25 |

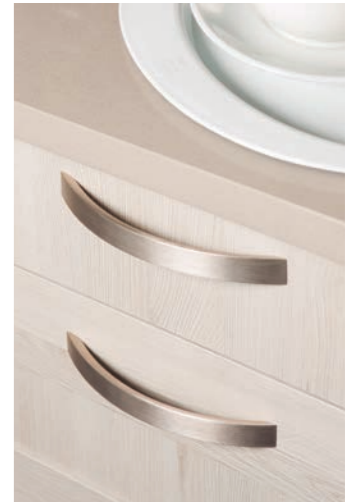

0092 **GLASS** ZAMAK + GLASS Design: Viefe®

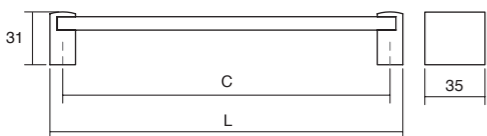

| 01 + V1 | C | L | ↓ | ☐ |
|---------------------------------|-----|-----|---|----|
| Polished chrome + Temper glass | | | | |
| Cromo brillo + Vidrio temperado | | | | |
| 0092035C01V1 | - | 30 | 2 | 25 |
| 0092160C01V1 | 160 | 175 | 2 | 25 |
| 0092192C01V1 | 192 | 207 | 2 | 25 |
| 0092320C01V1 | 320 | 335 | 2 | 25 |

0064 **KOMBI** STAINLESS STEEL Design: Viefe®

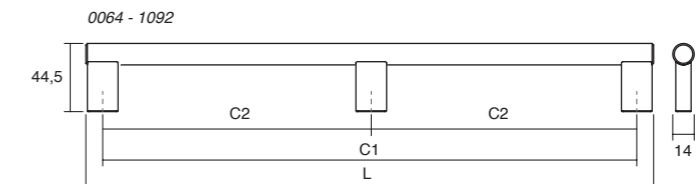
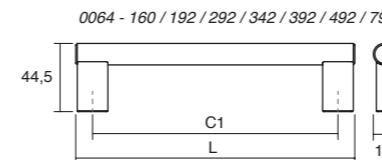

| 25 | C1 | C2 | L | ↓ | ☐ |
|-------------------------|------|-----|------|---|----|
| Brushed stainless steel | | | | | |
| Inox cepillado | | | | | |
| 0064160S25 | 160 | - | 182 | 2 | 25 |
| 0064192S25 | 192 | - | 214 | 2 | 25 |
| 0064292S25 | 292 | - | 314 | 2 | 25 |
| 0064342S25 | 342 | - | 364 | 2 | 25 |
| 0064392S25 | 392 | - | 414 | 2 | 25 |
| 0064492S25 | 492 | - | 514 | 2 | 25 |
| 0064792S25 | 792 | - | 814 | 2 | 10 |
| 00641092S25 | 1092 | 546 | 1114 | 3 | 10 |



0315 **ZAPA**

ZAMAK

Design: Oriol Barri

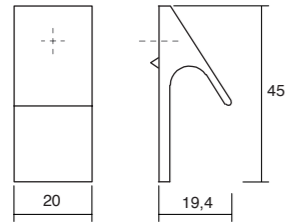

| 01 | 11 | 23 | |
|--|----------------------------------|---|------|
| Polished chrome <i>Cromo brillo</i> | Matt chrome <i>Cromo mate</i> | Brushed nickel <i>Níquel cepillado</i> | ↓ |
| 0315020Z01 | 0315020Z11 | 0315020Z23 | 1 25 |

Includes non-twisting tip / Incluye punta anti-giro

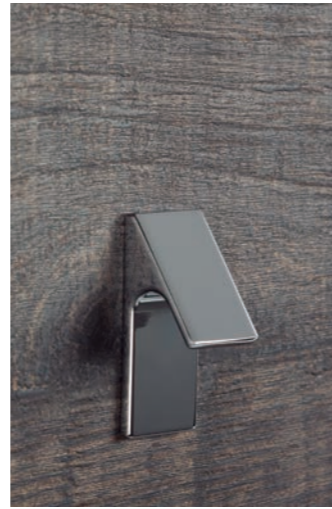

6005 **FONDA**

ALUMINIUM

Design: Viefe®

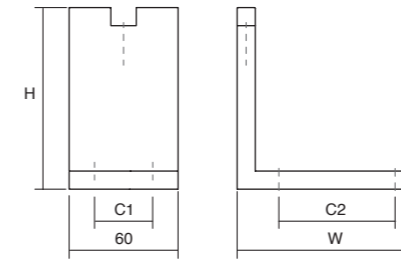

| 01 | 24 | 29 | 30 | C1 | C2 | W | H | ↓ | |
|--|--|---|---|----|----|-----|-----|---|----|
| Polished chrome <i>Cromo brillo</i> | Stainless steel look <i>Inox look</i> | Brushed brass dark <i>Latón oscuro cepillado</i> | Brushed black <i>Negro cepillado</i> | | | | | | |
| 6005100L01 | 6005100L24 | 6005100L29 | 6005100L30 | 32 | 44 | 80 | 100 | 4 | 24 |
| 6005150L01 | 6005150L24 | 6005150L29 | 6005150L30 | 32 | 44 | 80 | 150 | 4 | 24 |
| 6005200L01 | 6005200L24 | 6005200L29 | 6005200L30 | 32 | 64 | 100 | 200 | 4 | 24 |



0114 **HOOK**

ZAMAK

Design: 2J Design

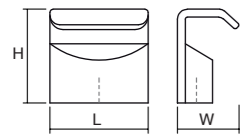

| 01 | 23 | L | W | H | ↓ | |
|--|---|----|----|----|---|----|
| Polished chrome <i>Cromo brillo</i> | Brushed nickel <i>Níquel cepillado</i> | | | | | |
| 0114030Z01 | 0114030Z23 | 30 | 20 | 28 | 1 | 25 |

Includes non-twisting tip / Incluye punta anti-giro



6003 **JAZZ**

ALUMINIUM

Design: Viefe®

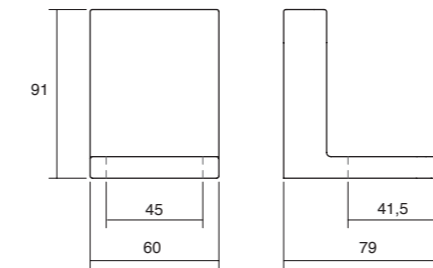

| 01 | P1 | ↓ | |
|--|----------------------------------|---|----|
| Polished chrome <i>Cromo brillo</i> | Chrome look <i>Cromo look</i> | | |
| 6003045Z01 | 6003045ZP1 | 4 | 24 |



0035 **ACER**

STAINLESS STEEL

Design: 2J Design

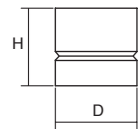

| 25 | D | H | ↓ | |
|---|----|----|---|----|
| Brushed stain. steel <i>Inox cepillado</i> | | | | |
| 0035018S25 | 18 | 23 | 1 | 25 |
| 0035023S25 | 23 | 25 | 1 | 25 |
| 0035028S25 | 28 | 27 | 1 | 25 |



INDEX

| Model | Product pag | Tech info pag |
|--------------------------|-------------|---------------|
| 0035 ACER | 233 | 282 |
| 0053 DINO | 188 | 264 |
| 0056 U | 94 | 250 |
| 0064 KOMBI | 233 | 281 |
| 0073 TAP | 156 | 260 |
| 0076 FORT | 231 | 281 |
| 0077 ANGLE | 62 | 262 |
| 0091 RASO | 234 | 279 |
| 0092 GLASS | 231 | 280 |
| 0094 HIDE | 146 | 258 |
| 0105 NEST | 150 | 259 |
| 0108 TWISTED | 194 | 271 |
| 0109 GRAF | 130 | 257 |
| 0114 HOOK | 228 | 282 |
| 0117 CURVE | 176 | 267 |
| 0119 WAVE | 148 | 259 |
| 0127 JEY | 70 | 247 |
| 0127 / 0163 JEY/JEY2 | 72 | 247 |
| 0139 / 0140 LINEAR | 178 | 267 |
| 0162 KADO | 232 | 261 |
| 0163 JEY2 | 72 | 247 |
| 0165 CALIN | 216 | 276 |
| 0166 ECHO | 218 | 277 |
| 0167 BALTO | 219 | 277 |
| 0168 COMO | 76 | 248 |
| 0195 SENSE | 161 | 261 |
| 0204 RADI | 223 | 278 |
| 0206 ARCH | 232 | 265 |
| 0208 DUA | 224 | 279 |
| 0219 ARROW | 229 | 271 |
| 0226 REDO | 200 | 273 |
| 0235 CLOS | 152 | 259 |
| 0239 ARA | 195 | 271 |
| 0239 ARA W | 212 | 276 |
| 0241 ROMA | 98 | 251 |
| 0243 ST LOW ST | 222 | 278 |
| 0249 FERRI | 230 | 280 |
| 0250 / 0251 / 0253 FORMA | 183 | 269 |
| 0254 / 0255 NOMA | 58 | 268 |
| 0255 NOMA | 58 | 268 |
| 0281 FLAT | 220 | 278 |
| 0301 SENSE MINI | 158 | 260 |
| 0311 TAMM | 186 | 263 |
| 0312 ARKO | 234 | 281 |
| 0315 ZAPA | 228 | 282 |
| 0322 CUTT | 192 | 266 |
| 0326 TACCO | 217 | 277 |
| 0334 BRIKK | 184 | 269 |
| 0340 BARCCO | 214 | 276 |
| 0341 ASI | 170 | 262 |
| 0343 GRADA | 187 | 270 |
| 0366 CUBIC | 154 | 260 |
| 0369 RITTA | 230 | 280 |
| 0372 ONA | 54 | 265 |
| 0373 NICK | 190 | 261 |

| | | |
|---------------------------|-----|-----|
| 0374 BALL | 225 | 272 |
| 0375 VANN | 172 | 266 |
| 0376 BOXX | 226 | 279 |
| 0379 / 0380 / 0382 STEEP | 182 | 270 |
| 0390 PETRA | 207 | 274 |
| 0391 AURA | 209 | 275 |
| 0392 ORION | 208 | 274 |
| 0393 DUKE | 198 | 272 |
| 0394 AVA | 206 | 274 |
| 0404 FLEXA | 210 | 275 |
| 0405 RAVIOLO | 204 | 273 |
| 0410 BUTTON | 196 | 272 |
| 0411 VERSO | 202 | 273 |
| 0430 GRAF MINI | 128 | 256 |
| 0434 / 0435 / 0436 VECTOR | 180 | 268 |
| 0444 PEAK | 166 | 264 |
| 0446 ESTE | 138 | 255 |
| 0447 BELLA | 140 | 257 |
| 0449 HEXXA | 142 | 258 |
| 0451 FELTRE | 162 | 257 |
| 0452 BRAVE | 164 | 263 |
| 0459 LINES | 132 | 252 |
| 0467 SKALA | 134 | 253 |
| 0480 NICE | 136 | 254 |
| 0486 GRAF BIG | 122 | 256 |
| 0487 PURA | 74 | 246 |
| 0489 BOL | 104 | 251 |
| 0490 SWITCH | 84 | 249 |
| 0494 LAND | 110 | 253 |
| 0495 FLOID | 66 | 246 |
| 0496 BAU | 68 | 246 |
| 0497 DIABOLO | 80 | 248 |
| 0499 ROUND | 82 | 248 |
| 0503 WALLACE | 102 | 251 |
| 0506 FIRM | 114 | 254 |
| 0507 OBLONG | 106 | 252 |
| 0511 RAIL | 90 | 250 |
| 0516 PENDANT | 118 | 255 |
| 0518 WAY | 86 | 249 |
| 0528 RILLE | 16 | 240 |
| 0530 DISC (wood) | 22 | 241 |
| 0530 DISC (zamak) | 24 | 241 |
| 0536 LUV | 26 | 240 |
| 0538 CONIC (wood) | 30 | 241 |
| 0538 CONIC (zamak) | 32 | 242 |
| 0542 FOLD | 34 | 242 |
| 0543 SOFT | 38 | 243 |
| 0552 RIM | 42 | 243 |
| 0553 OTO | 44 | 244 |
| 0556 DIPO | 46 | 244 |
| 0583 ARPA | 48 | 245 |
| 0588 ARPA PLATE | 52 | 245 |
| 6003 JAZZ | 235 | 283 |
| 6005 FONDA | 236 | 283 |

20
22

Viefe[®]

—
**HANDLES & KNOBS
CATALOGUE**

🌐 **viefe.com**

Viefe®

20
22

🌐 viefe.com

viefe.com/news



info@viefe.com
T +34 938584029

C/ Dels Traginers 2
Pol. Ind. La Guàrdia
Sant Pere de Torelló
08572 Barcelona, Spain